

INSTALLATION GUIDE

BEFORE YOU START

- To ensure that the installation and erection of your Stratco Handi-Mate™ Shed proceeds smoothly you should confirm that all the components and materials listed on the delivery documentation and in this installation guide have been supplied. Details for ordering individual components can be found in the "Component Index" section at the end of this document.
- Carefully read this installation guide to familiarise yourself with all the steps involved and ensure that you have the correct tools and equipment for the job.
- There are different types and colours of screws. Ensure that the right type and colour screw is being used at each location.
- Use heavy gloves when handling steel sheeting and flashings and never attempt to install a shed in windy conditions.
- It is important that you contact your local government authority to determine if building approval is required.
- Stability and performance of the shed relies on the door being closed during high wind events.
- It is essential to clear and level the site prior to assembling your Stratco Handi-Mate™ Shed.
- Do not traverse the roof of the Handi-Mate™.
- The installer is responsible for ensuring the slab or concrete pads are sufficient to support the shed and sustain wind loading. Do not directly anchor your shed to pavers. All Stratco Handi-Mate™ Sheds must be securely bolted to a permanent concrete base with sufficient masonry anchors as specified in Figure 5.4 to prevent wind uplift.

Option 1 - Before building the shed, pour a base that is larger than the area by at least 200mm in each direction. The base should be poured so the concrete outside the shed floor area slopes away from the shed to help prevent water from entering the shed.

Option 2 - Substantial concrete pads may be used at each anchor location as an alternative to a complete concrete floor. It is recommended pads are minimum Ø250mm x 400mm deep, embedded into a firm natural soil base.

- Where necessary, components are marked with a coloured sticker as to easily differentiate one from another. Components are referenced throughout the installation guide by their colour. For example, Panel (Short) is marked with a red ● sticker.







SHED WINDOWS (OPTIONAL)

Stratco Shed Windows are available as an optional add-on, available in both Louvre and Sliding variations. Handi-Mate Windows should be purchased along side the Handi-Mate Shed and installed during the Handi-Mate Shed assembly. Refer to the "Window Installation" section if installing a Stratco Window, or visit your local Stratco store for more information.

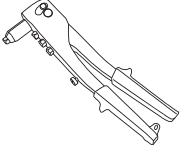
HANDI-MATE™ HM8 HINGED DOOR SHED

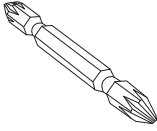
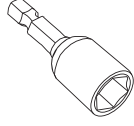
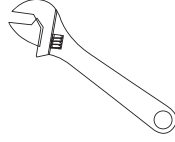
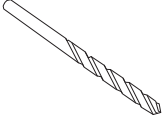
HANDI-MATE™ HM8 HINGED DOOR SHED INSTALLATION GUIDE

TOOLS REQUIRED

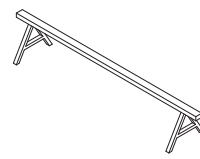
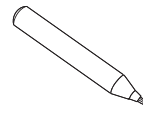
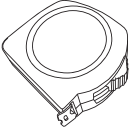
Rivet Gun 	Power Drill 	PH2 Phillips Head Bit (Supplied) 	3/16 Hex Head Bit (Supplied) 	Adjustable Spanner 	3.5mm Bit (Supplied) 12mm Bit 10mm Masonry Bit 
Gloves 	Safety Glasses 	Step Ladder 	2 x Trestles 	Permanent Marker 	Tape Measure 



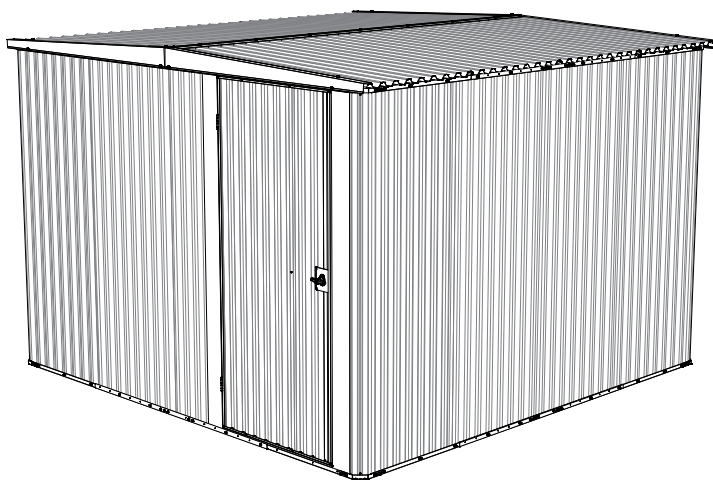
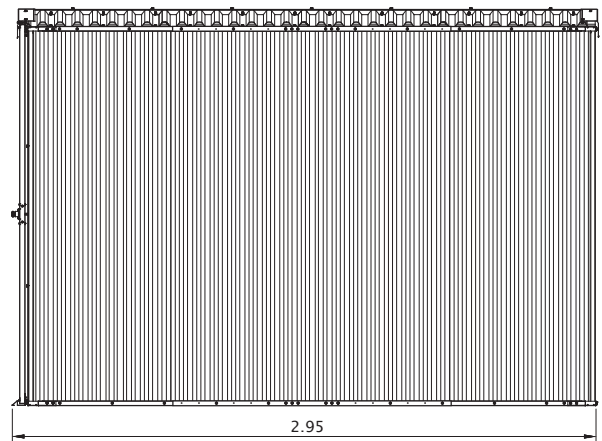
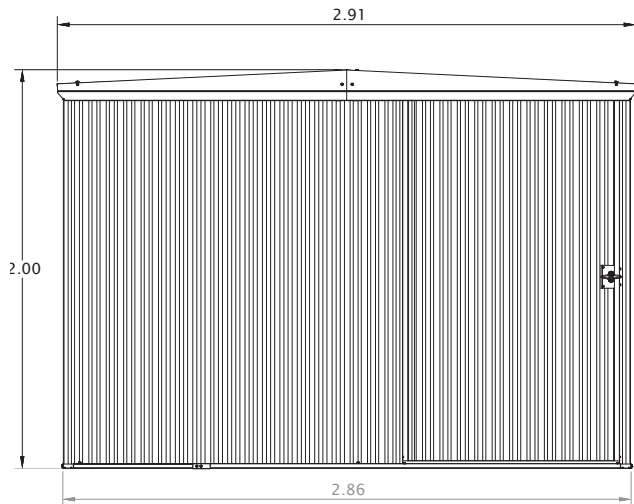







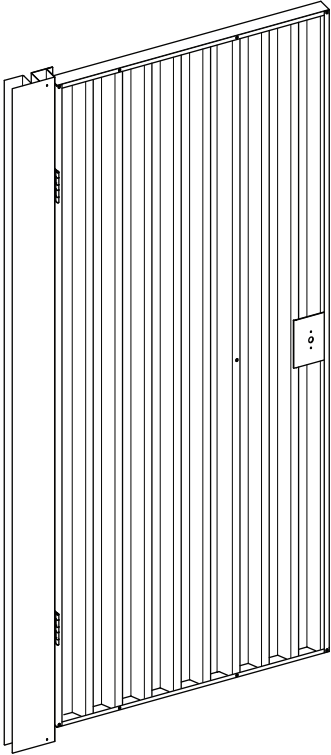
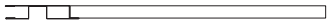
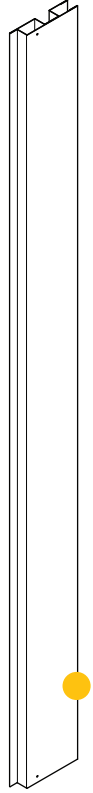



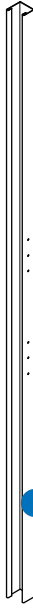



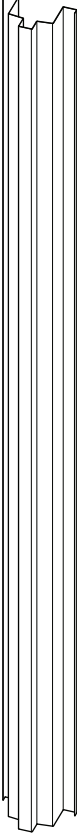

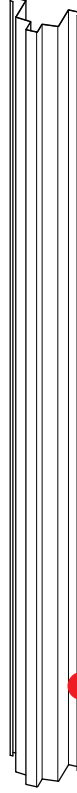





HANDI-MATE™ DIMENSIONS

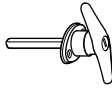
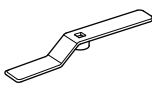
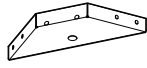

HANDI-MATE™ SHED WINDOWS

Stratco Handi-Mate Shed Windows are available as an optional add-on. For HM8 size Handi-Mates, the Window can be installed to the front, side or rear walls. Handi-Mate Windows should be installed during the Handi-Mate Shed assembly. Refer to the "Window Installation" section at the end of this document if installing a Stratco Window, or visit a Stratco store for more information.

COMPONENTS

<p>Door x 1</p>  	<p>Door Jamb x 1</p>  	<p>Wall Channel x 16</p>  	<p>Wall Channel Joiner x 8</p>  	<p>Ridge Cap x 2</p>  	<p>Ridge Beam x 1</p>  	<p>Ridge Beam Joiner x 1</p>  
<p>L/H Barge Cap x 2</p>  	<p>R/H Barge Cap x 2</p>  	<p>Door Shroud x 1</p>  	<p>Door Handle x 1</p> 	<p>Door Tongue x 1</p> 	<p>Corner Bracket x 8</p> 	<p>Hold Down Lug x 8</p> 
<p>M8x47 Masonry Anchor x 12</p> 			<p>Coloured Rivet x 35</p> 	<p>10x16 Wafer- Head Screw x 3</p> 		
<p>10x16 Hex-Head Screw x 200</p> 			<p>10x16 Hex-Head Coloured Screw (with neo washer) x 75</p> 	<p>10x25 Hex-Head Coloured Screw (with neo washer) x 22</p> 		

COMPONENTS

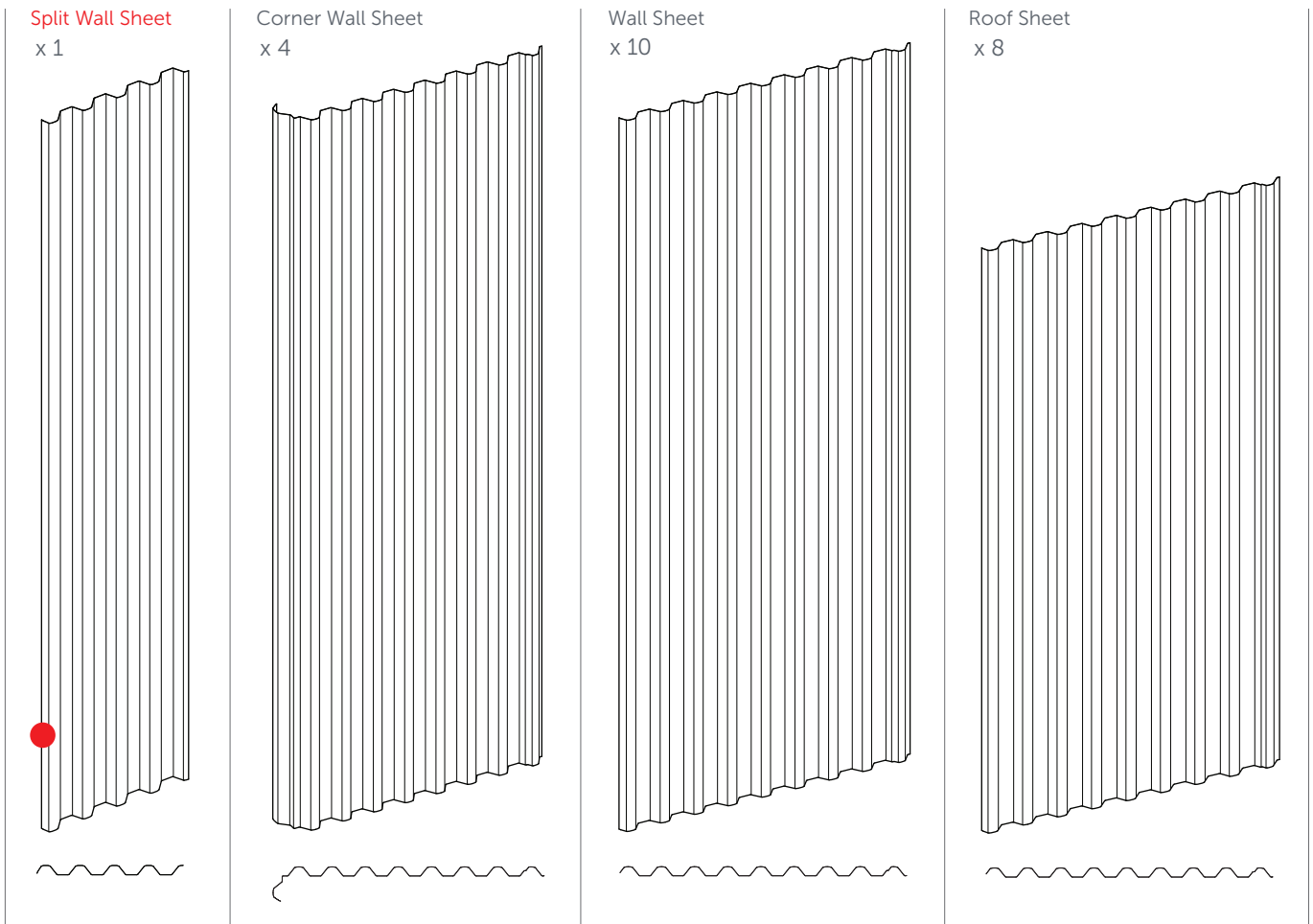

ASSEMBLY HANDY HINTS

The 'Sheet Crest', as referenced throughout this guide, refers to the curved top faces of the sheet.

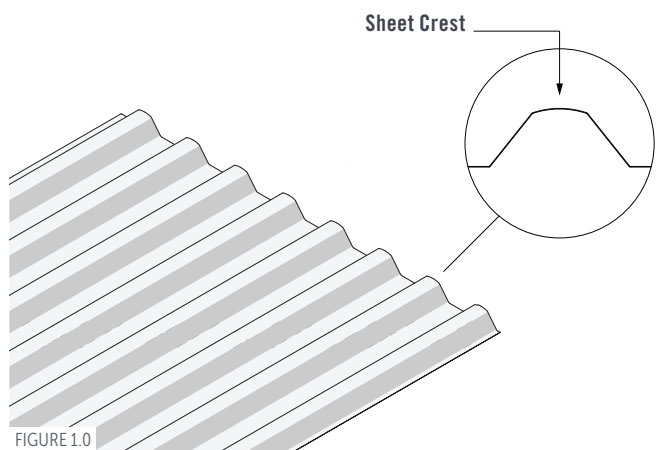

When assembling the Wall and Door Sheets, lay the sheets down on trestles/blocks (Figure 1.1). This will make assembly easier and reduce the risk of damage to components.

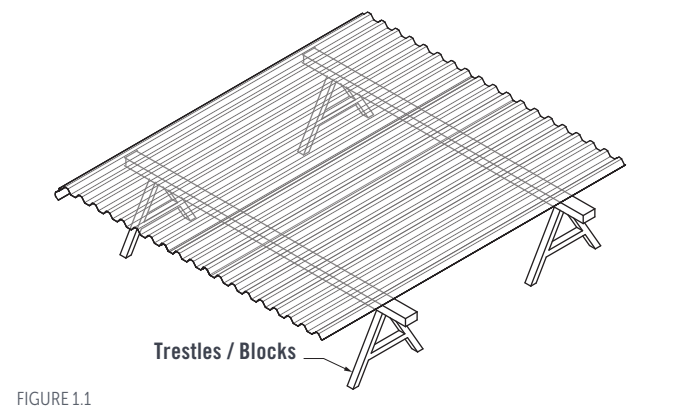

(Optional) Drainage holes can be drilled to help trapped water flow out of the bottom Wall Channels. After assembling the Walls, drill 6mm holes spaced approximately 350mm apart through the bottom Wall Channels of each Wall. Ensure holes are located in-between Sheet crests. Ensure metal filings are removed from the channels as to prevent rust spots from forming.

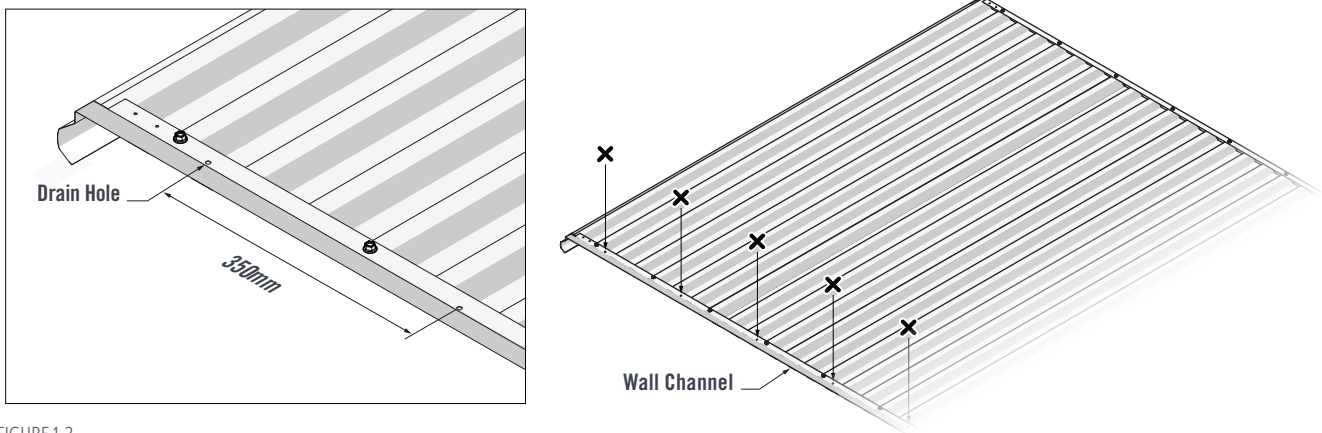

FIGURE 1.2

WALL CHANNEL ASSEMBLY

Slide two Wall Channels into a **Wall Channel Joiner**. Ensure the six middle pre-punched holes of the **Wall Channel Joiner** and Wall Channels line up. Fasten four 10x16 Hex-Head Screws through the four middle pilot holes of the **Wall Channel Joiner** and into the Wall Channels (Figure 2.0).

Assemble seven more Wall Channel Assemblies in the same manner so that there are eight Wall Channel Assemblies.

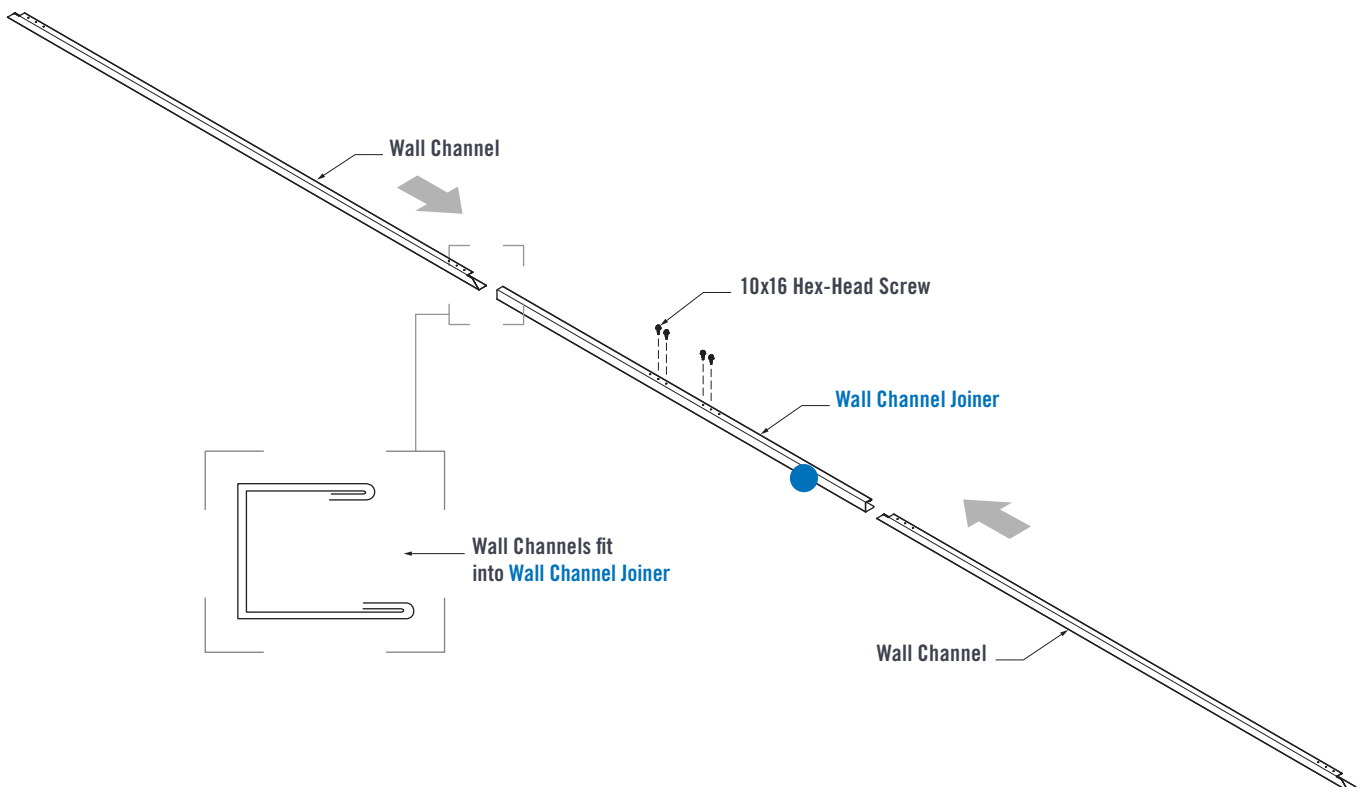

FIGURE 2.0

RIDGE BEAM ASSEMBLY

With the ends that have pre-punched holes facing each other, slide the Ridge Beam into the Ridge Beam Joiner (Figure 2.1).
1. Align the pilot holes of the Ridge Beam and Ridge Beam Joiner. Fasten four 10x16 Hex-Head Screws through the Ridge Beam Joiner and into the Ridge Beam on both sides (Figure 2.1).

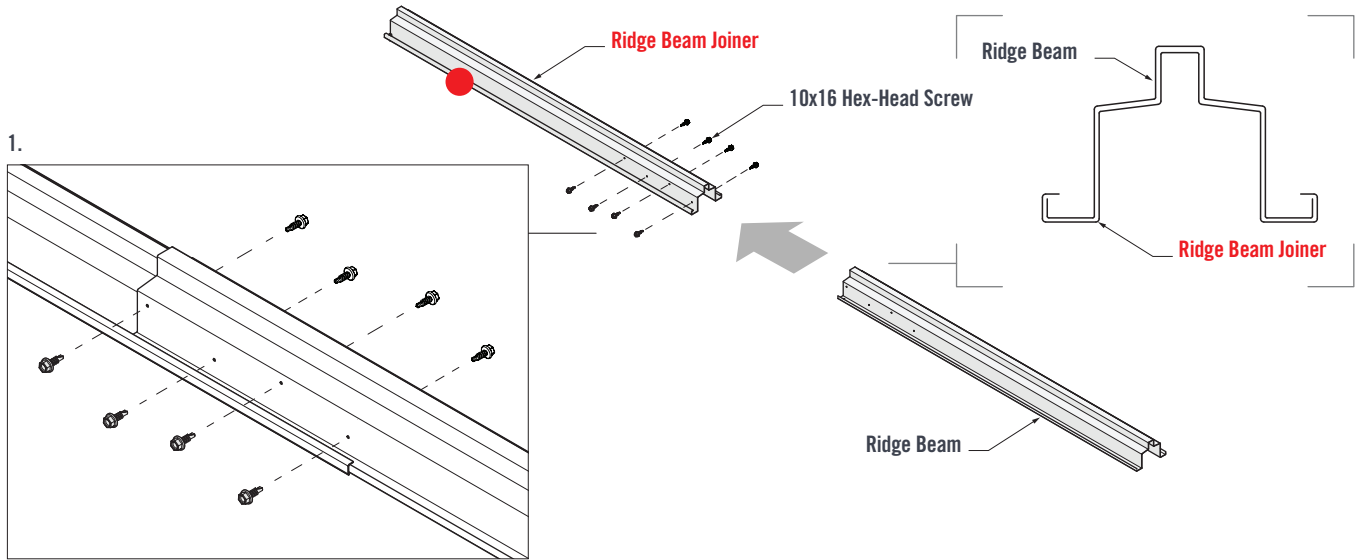

FIGURE 2.1

WALL ASSEMBLY

Stratco Handi-Mate Windows

Refer to the "Window Installation" section at the end of this document if installing a Stratco Window, or visit a Stratco store for more information.

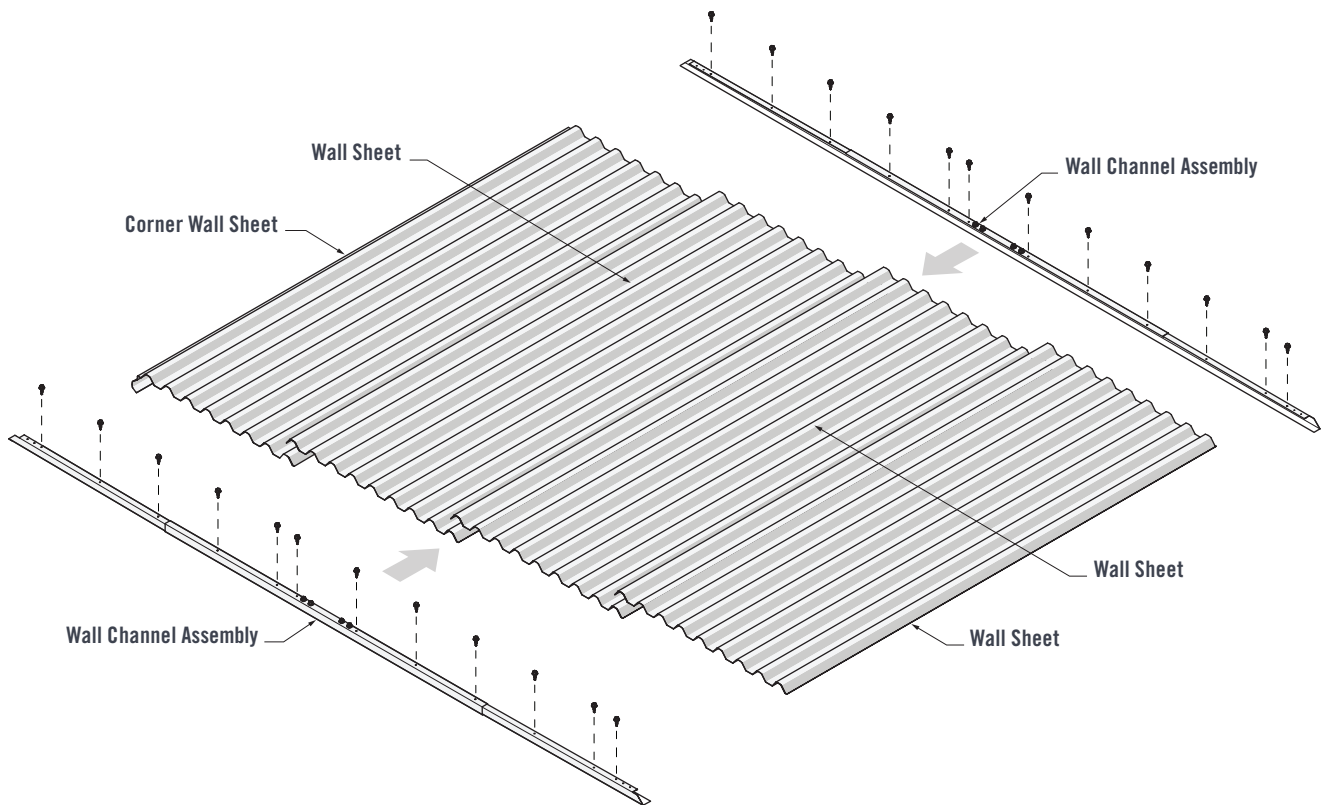

FIGURE 3.0

Using Trestles or Blocks to support the sheets, lay the Corner Wall Sheet down first. Then lay down the three Wall Sheets. Pay attention to the 'overlap' and 'underlap' lapping details (Figure 3.1).

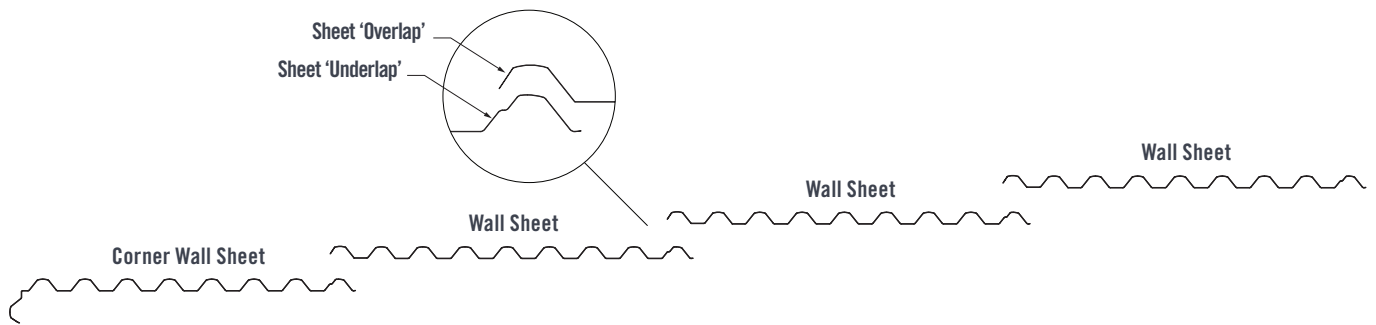

FIGURE 3.1

1. Fit the Wall Channel Assembly over the lapped Wall Sheets. The end of the Wall Channel should fit up against the end of the Corner Wall Sheet (Figure 3.2).

2. Wall Channels have three pilot holes in each end. Fasten through the third pilot hole of both Wall Channel ends and into the Wall Sheet crests. Fasten through the Wall Channel Assemblies and into every third Wall Sheet crest using ten 10x16 Hex-Head Screws in each Wall Channel Assembly (Figure 3.2).

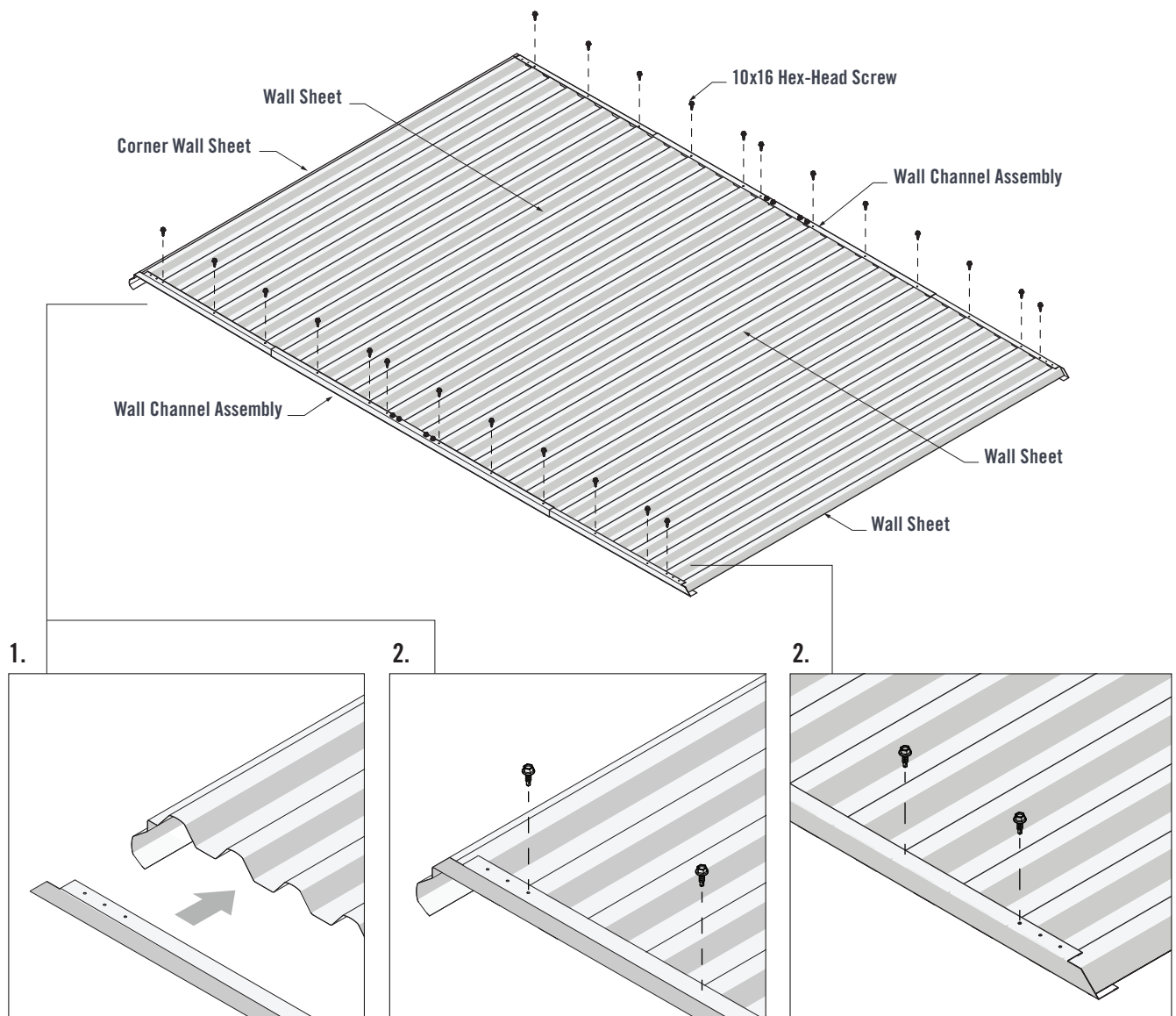

FIGURE 3.2

SECOND AND THIRD WALL ASSEMBLY

Repeat steps in Figures 3.0 to 3.2 to make two more Wall Assemblies, totalling three Wall Assemblies.

FRONT WALL ASSEMBLY

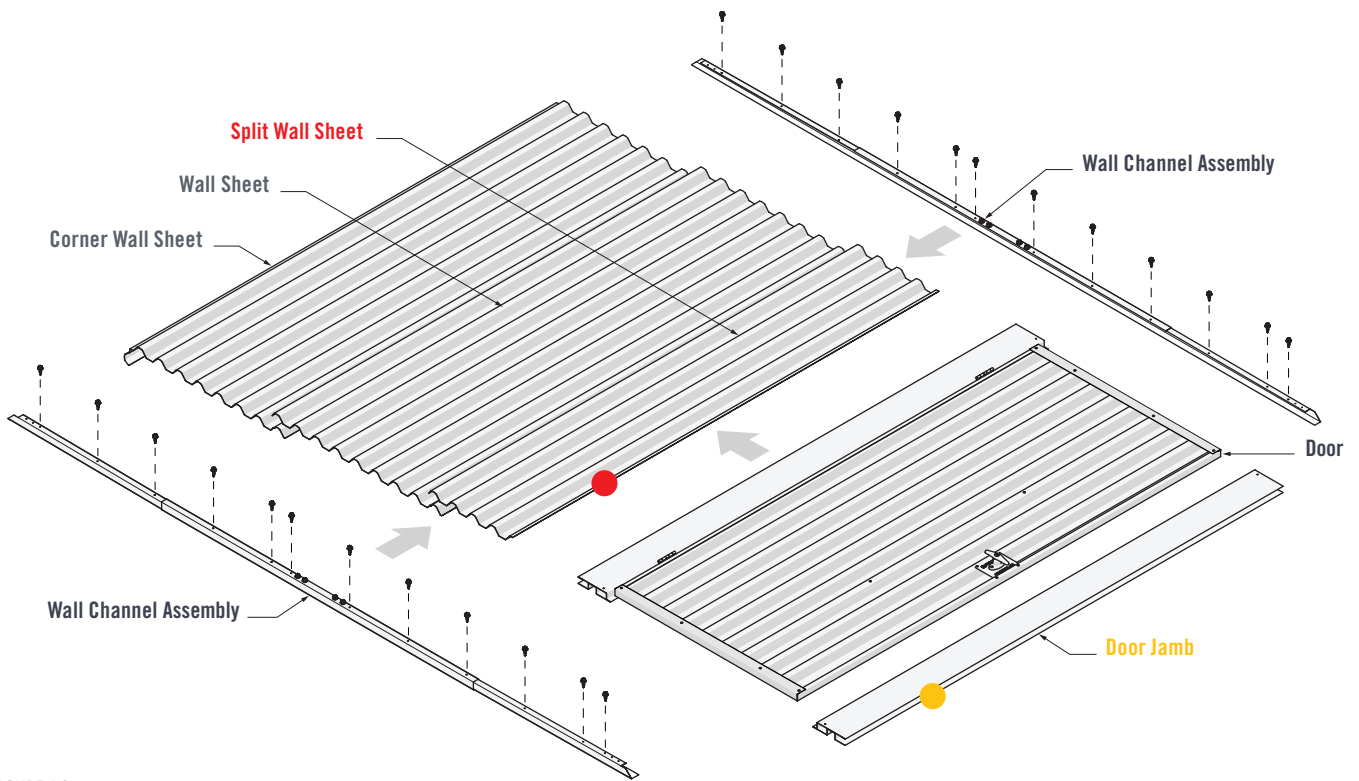

FIGURE 4.0

Lay out a **Corner Wall Sheet**, **Wall Sheet** and **Split Wall Sheet** onto trestles/blocks. Fit the **Door** over the **Split Wall Sheet** and then fit the **Door Jamb** up against the **Door**. (Figure 4.1).

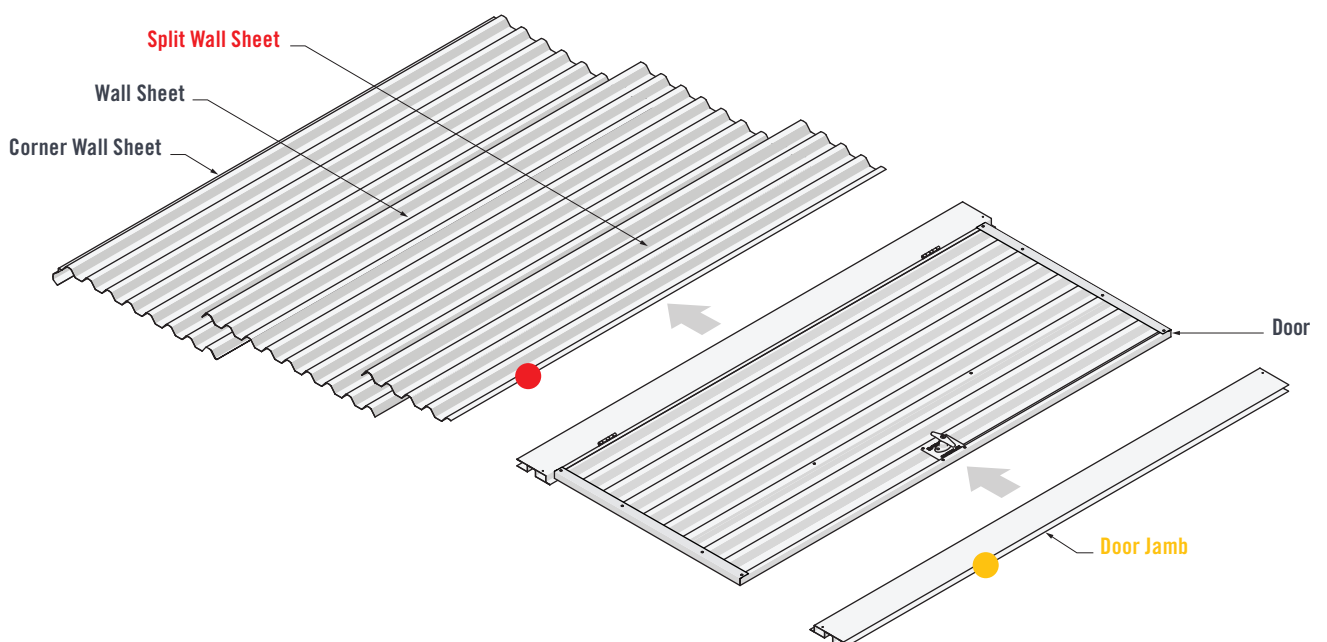

FIGURE 4.1 - CONTINUED NEXT PAGE

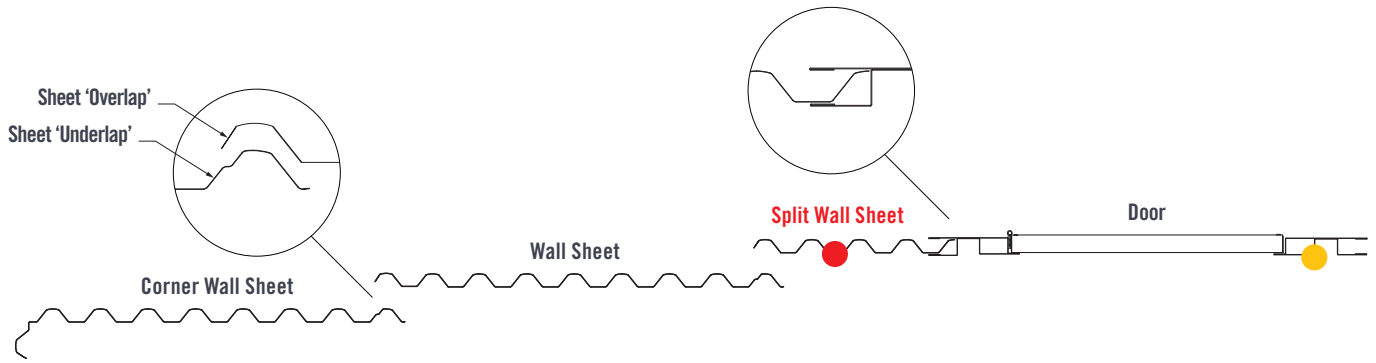

FIGURE 4.1

1. Fit two Wall Channel Assemblies over the lapped Wall Sheets and Door Jamb. The end of the Wall Channels should fit up against the end of the Corner Wall Sheet (Figure 4.2).
2. Fasten one 10x16 Hex-Head Screw through the third pilot hole of the bottom and top Wall Channels and into the Corner Wall Sheet crest. Fasten six 10x16 Hex-Head Screws through the bottom and top Wall Channels and into every third Wall Sheet crest (Figure 4.2).
3. Ensure the edge of the Wall Channels and Door Jamb are in-line. Fasten one 10x16 Hex-Head Screw through the third pilot hole of the bottom and top Wall Channels and into the Door Jamb (Figure 4.2).

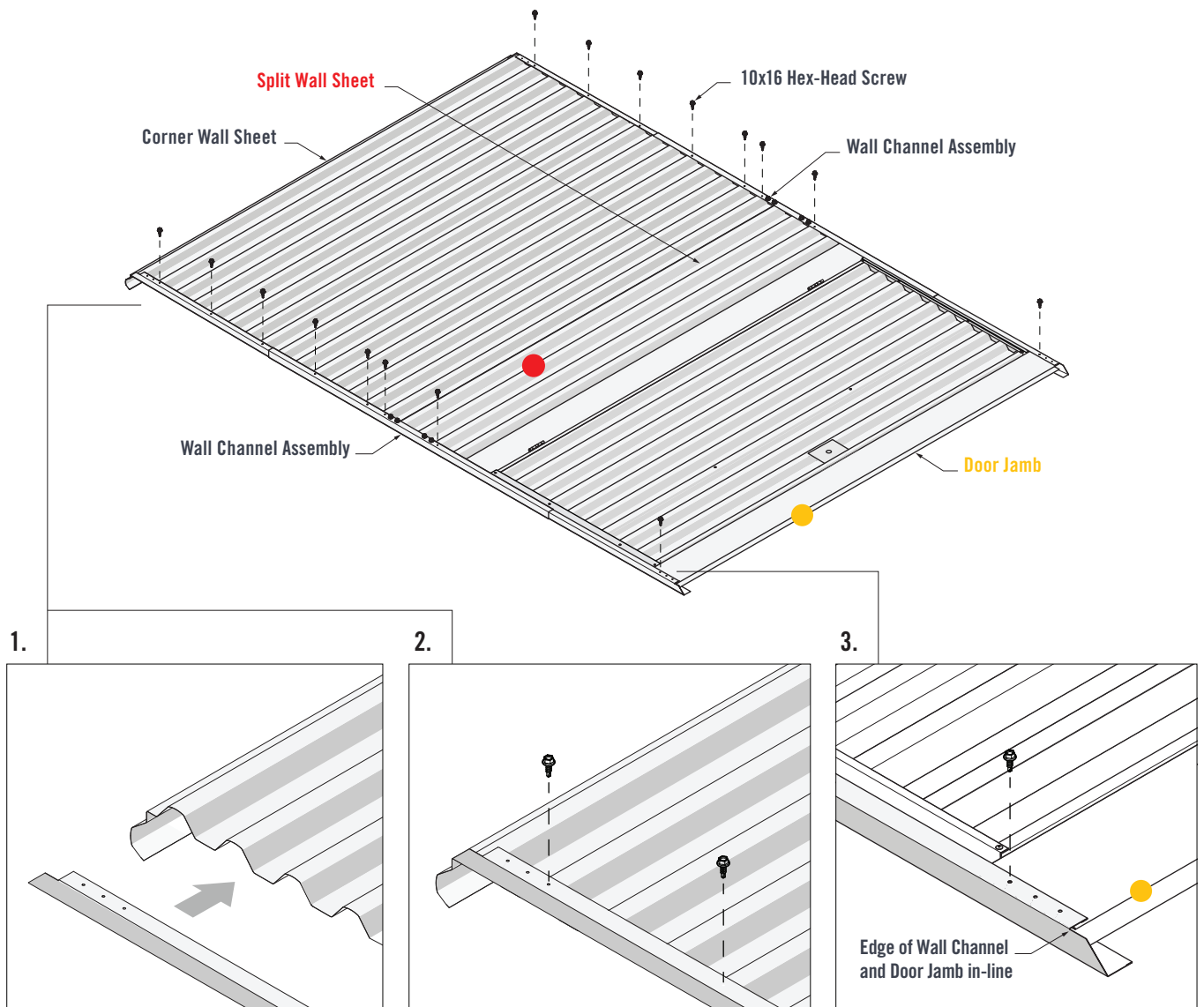

FIGURE 4.2

HANDI-MATE™ HM8 HINGED DOOR SHED INSTALLATION GUIDE

With the Door open, fit the **Door Shroud** in-between the **Door Jambs**. Use the **Door Shroud** as a guide to set the correct spacing between the **Door Jambs** (Figure 4.3).

1. Fasten two 10x16 Hex-Head Screws through both **Wall Channels** and into the **Door Jamb**. Close the Door and ensure an approximate 10mm gap between the edge of the Door and end **Door Jamb** (Figure 4.3).

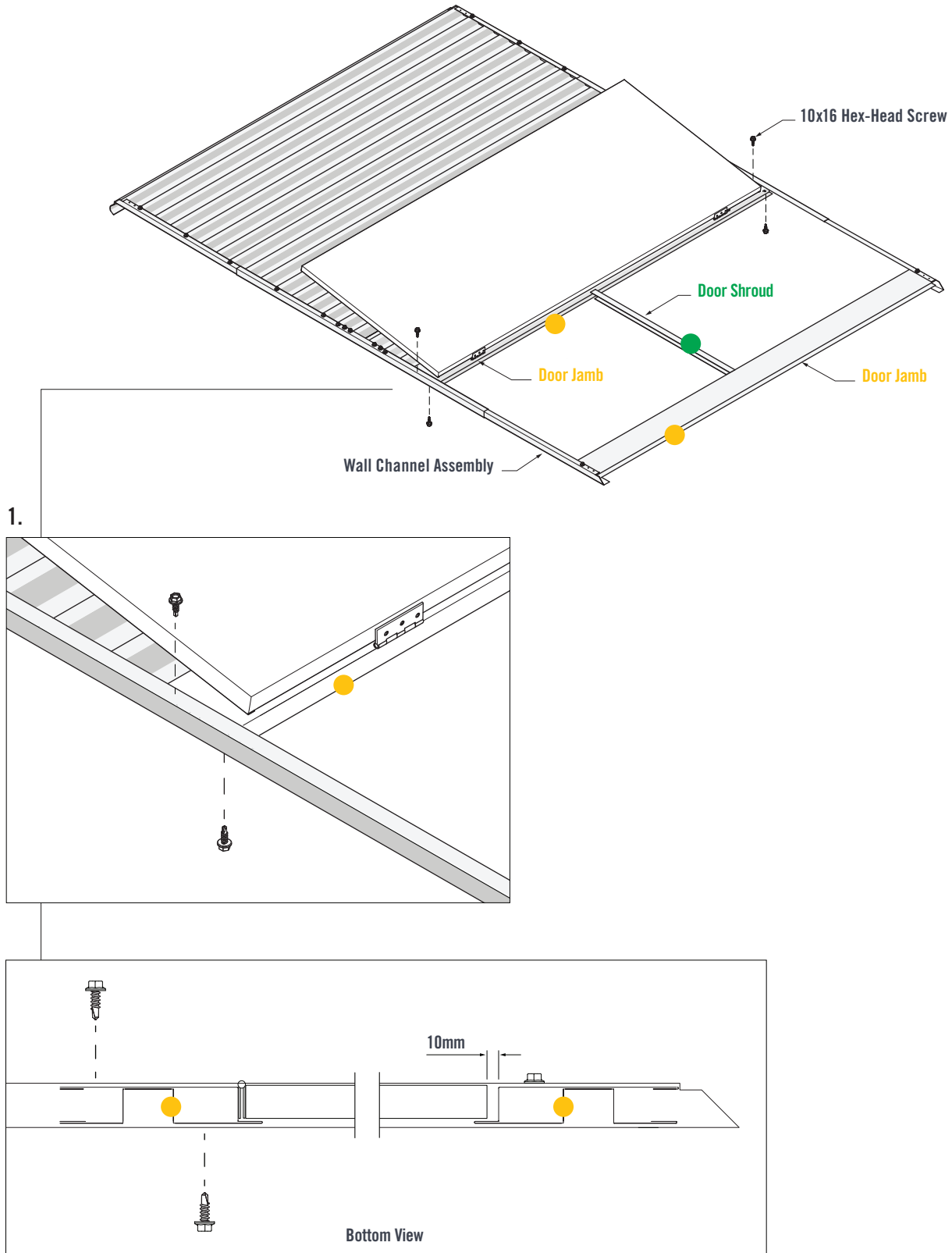

FIGURE 4.3

JOINING WALL ASSEMBLIES

The wall assemblies can now be joined together. Fit the Corner Wall Sheet of the Front Wall over the Side Wall Sheet. Ensure the Corner Sheet fits inside the Side Wall Channels (Figure 5.0).

1. Fit a Corner Bracket over the top Wall Channels. Ensure the pilot holes of the Corner Bracket and Wall Channels line up.
2. Fasten through the Corner Bracket pilot holes and into the top Wall Channels using four 10x16 Hex-Head Screws.
3. Fit a Corner Bracket to the bottom Wall Channels. Fasten through the Corner Bracket pilot holes and into the bottom Wall Channels using four 10x16 Hex-Head Screws (Figure 5.0).

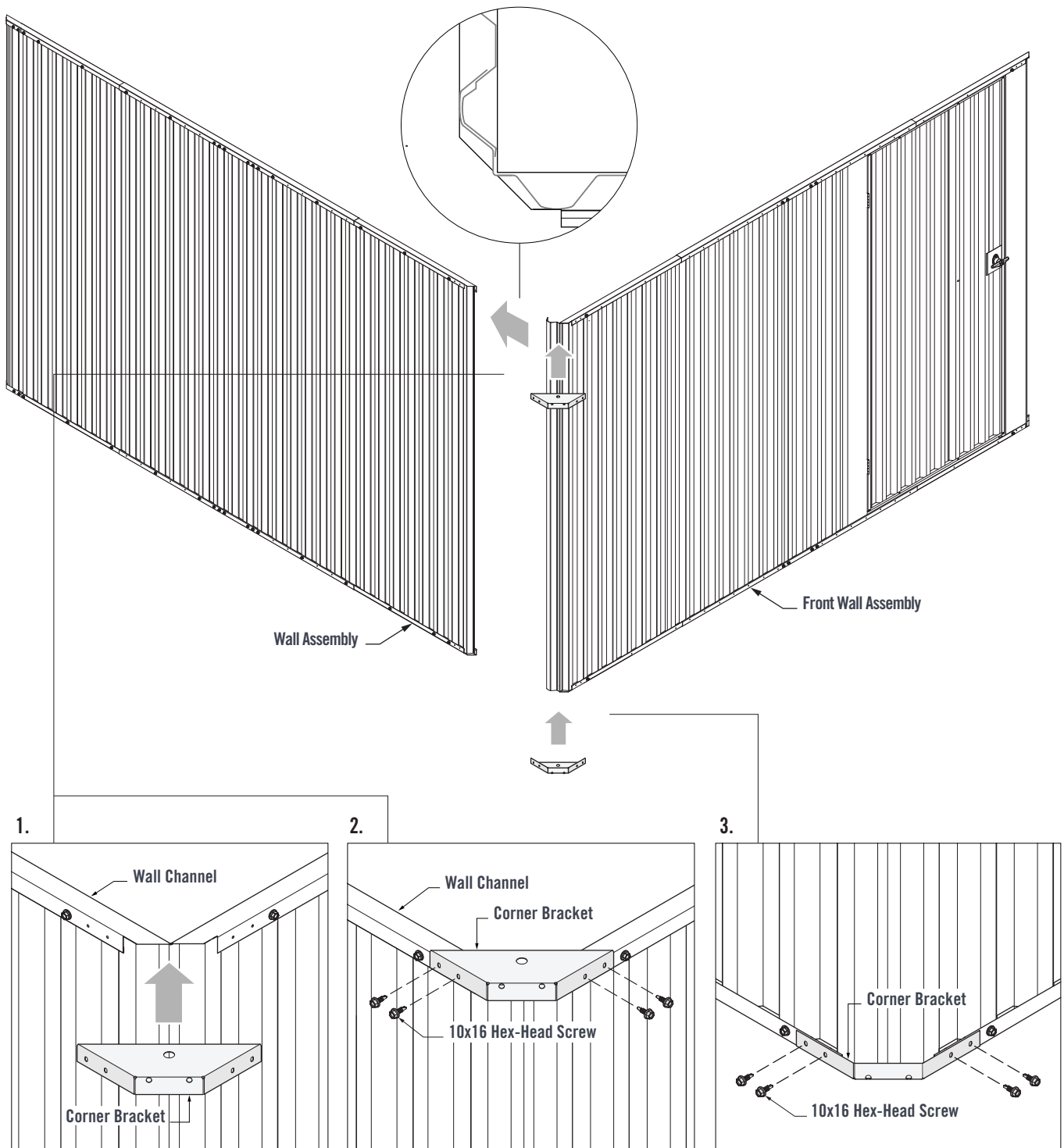

FIGURE 5.0

HANDI-MATE™ HM8 HINGED DOOR SHED INSTALLATION GUIDE

Fit the Remaining Wall Assemblies together with Corner Brackets as per Figure 5.0.

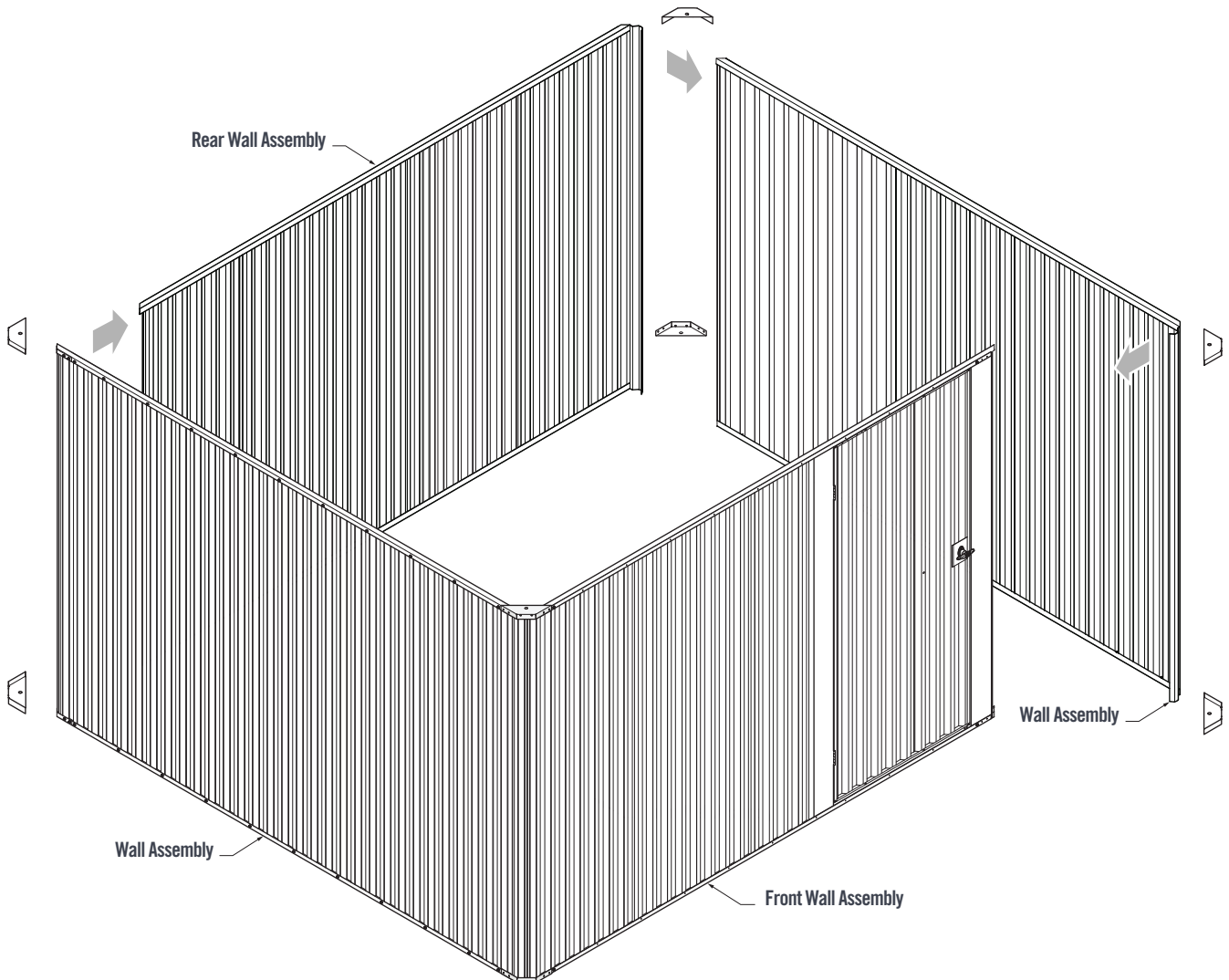

FIGURE 5.1

Fasten the Door Handle to the Handle Mount with two 10x16 Wafer-Head Screws. Fit the Door Tongue over the Door Handle shaft. Ensure the Door Tongue is oriented vertically and the Handle is oriented horizontally. Tighten the Door Tongue screw on the Door Handle shaft to secure the Door Tongue in place. Lastly, slide the Locking Washer onto the Door Handle shaft and up against the Door Tongue (Figure 5.2).

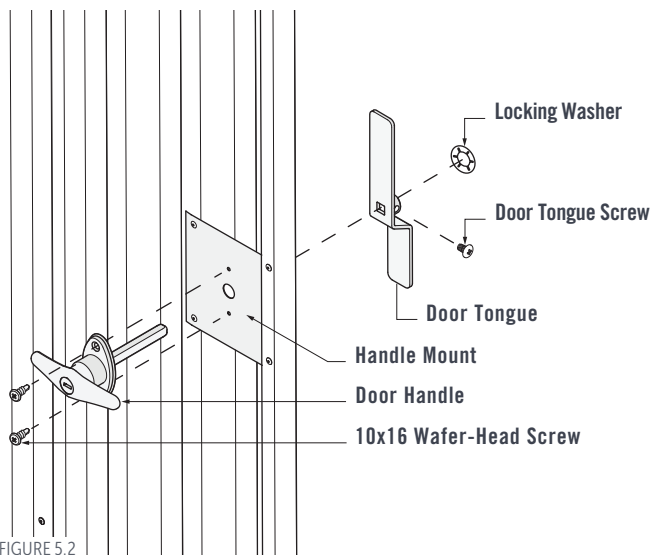
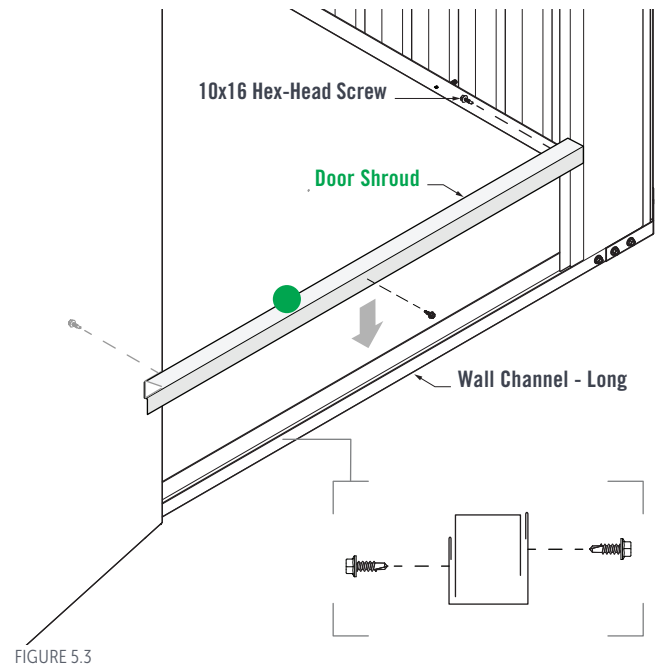

FIGURE 5.2

Fit the Door Shroud into the Wall Channel (Long). Fasten the Door Shroud to the Wall Channel with two 10x16 Hex-Head Screws (Figure 5.3).



Check the walls are square. Check the diagonal measurements from corner to corner. The diagonal measurements should be equal for the walls to be square.

Note: Shed anchoring requirements are determined by the wind zone the Handi-Mate is installed in. Contact a Stratco store for further information or to determine your wind zone.

The recommended anchor spacing in Figure 5.4 below, where anchor points are no greater than 900mm apart, will satisfy engineering requirements for N1, N2 and N3 wind zones.

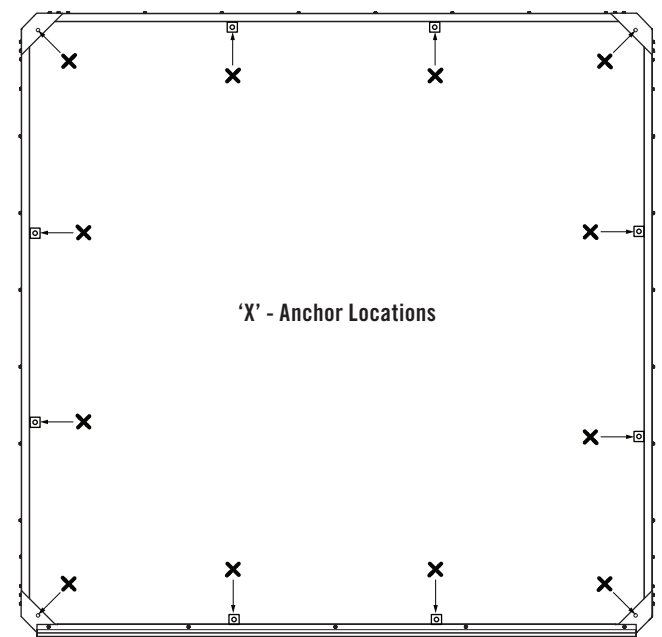

FIGURE 5.4

Using the Corner Bracket pilot holes as a guide, drill holes in all four corners with a 10mm masonry drill bit. Secure all four bottom Corner Brackets to the concrete base with M8x47 Masonry Anchors (Figure 5.5).

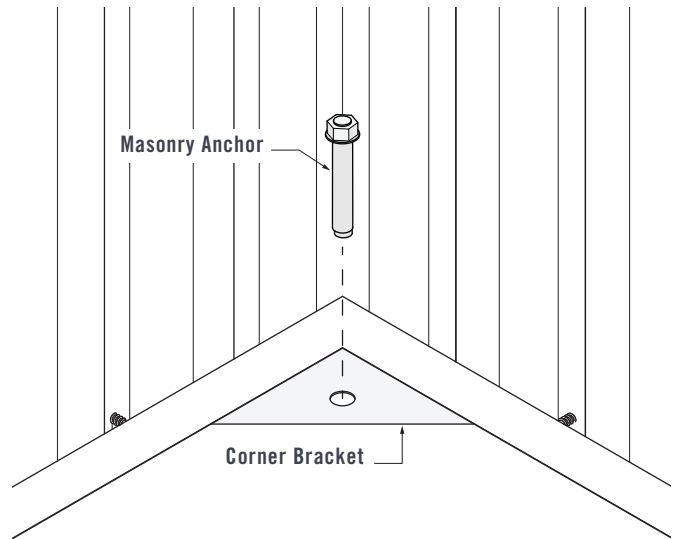

FIGURE 5.5

Fit a Hold Down Lug at the middle of both Long Wall Channels. Fasten one 10x16 Hex-Head Screw through each Hold Down Lug into the Wall Channel and Wall Sheet. Fix both Hold Down Lugs to the concrete base with M8x47 Masonry Anchors (Figure 5.6).

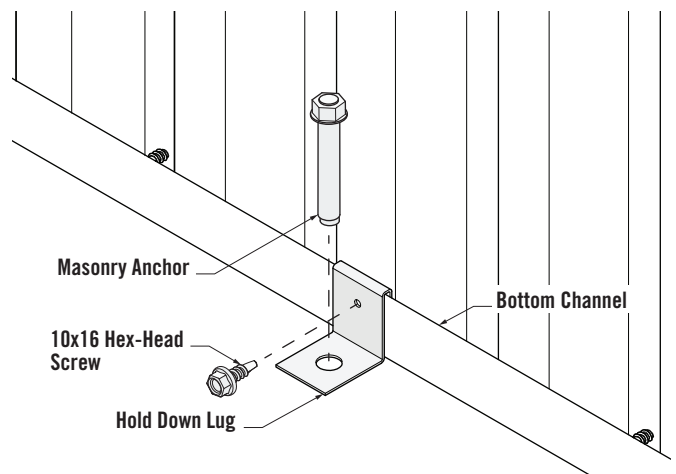

FIGURE 5.6

ROOF ASSEMBLY

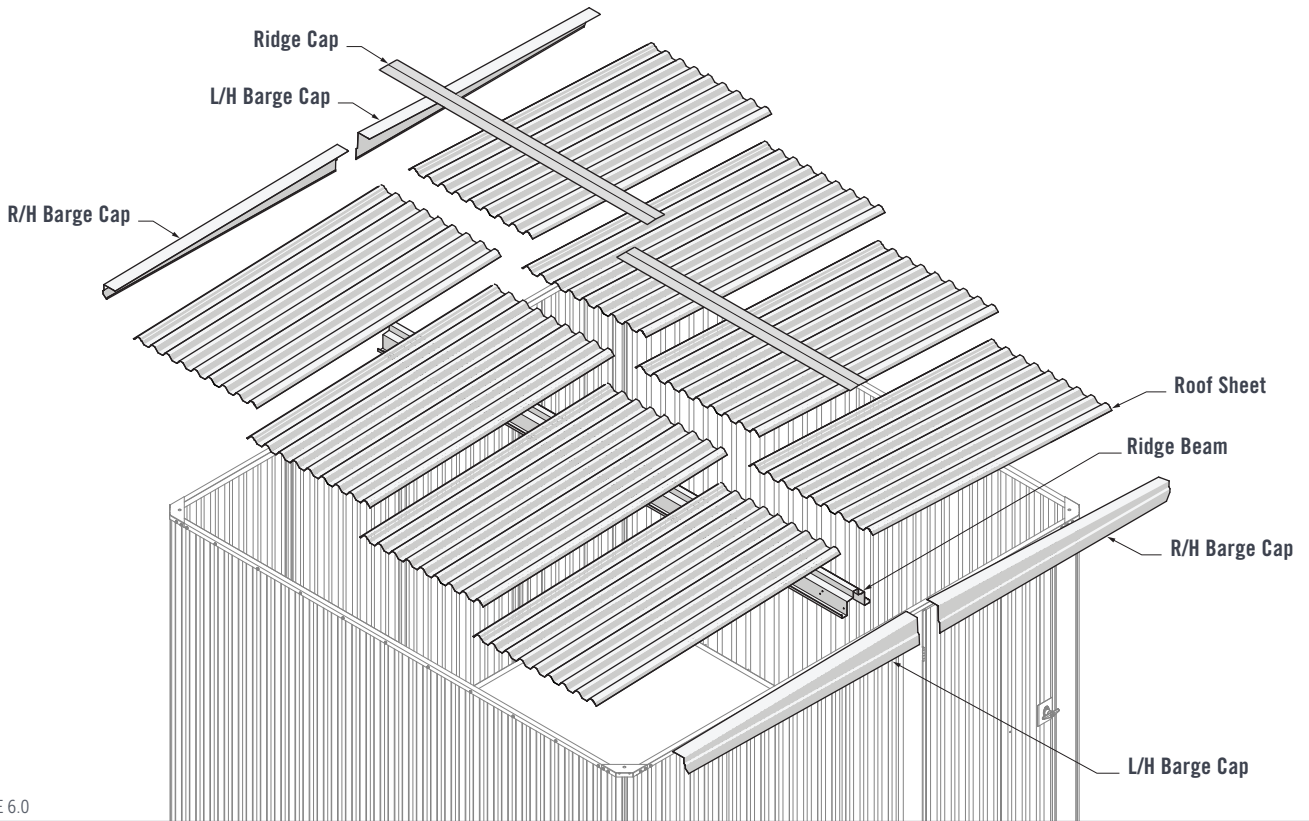

FIGURE 6.0

Use an adjustable spanner to turn up the pans at the ridge end of the Roof Sheets. This will prevent water flowing back under the sheet (Figure 6.1).

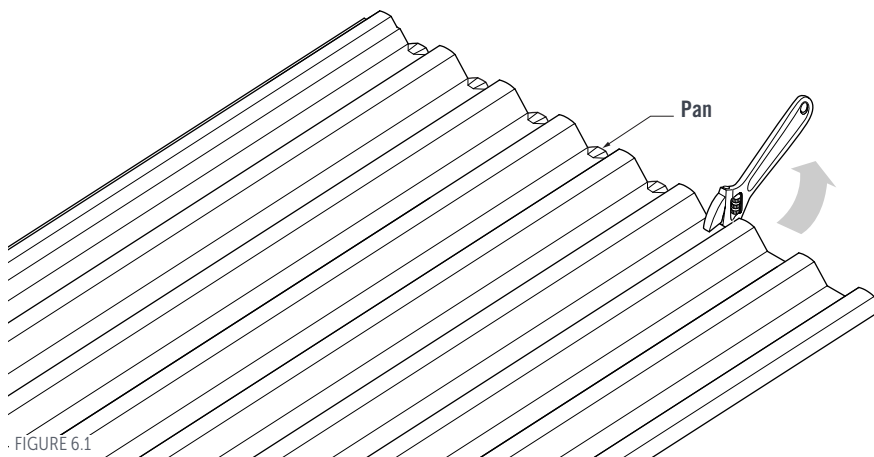

FIGURE 6.1

Refer to the sheet layout below when installing Roof Sheets (Figure 6.2).

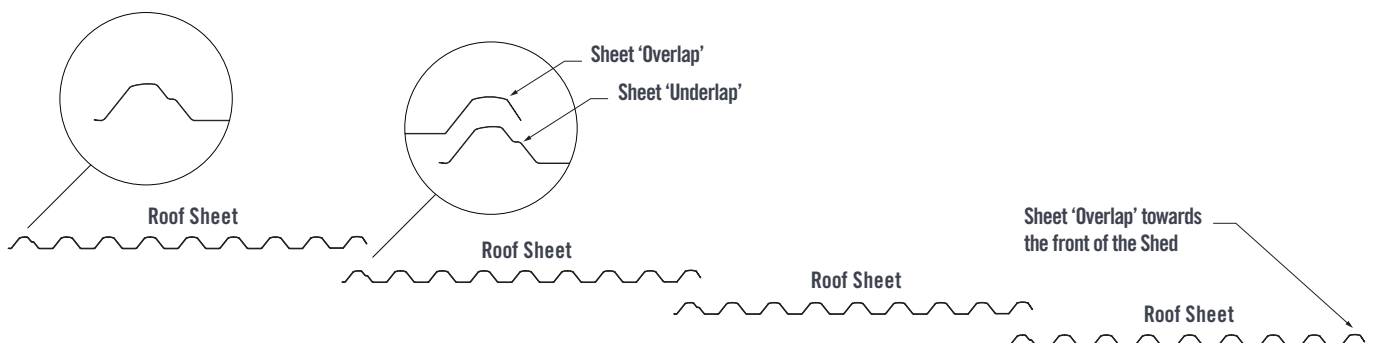

FIGURE 6.2

Fit the Ridge Beam onto the top Wall Channel Assemblies. Ensure 1355mm spacing between the edge of the shed and edge of the Ridge Beam (Figure 6.3).

1. Align the end of the Ridge Beam with the outer edge of the Wall Channel Assembly. Fasten two 10x16 Hex-Head Screws through the pilot holes in the Ridge Beam and into the Wall Channel Assembly (Figure 6.3).
2. Fasten two 10x16 Hex-Head Screws through the pilot holes in the Ridge Beam and into the rear Wall Channel Assembly (Figure 6.3).

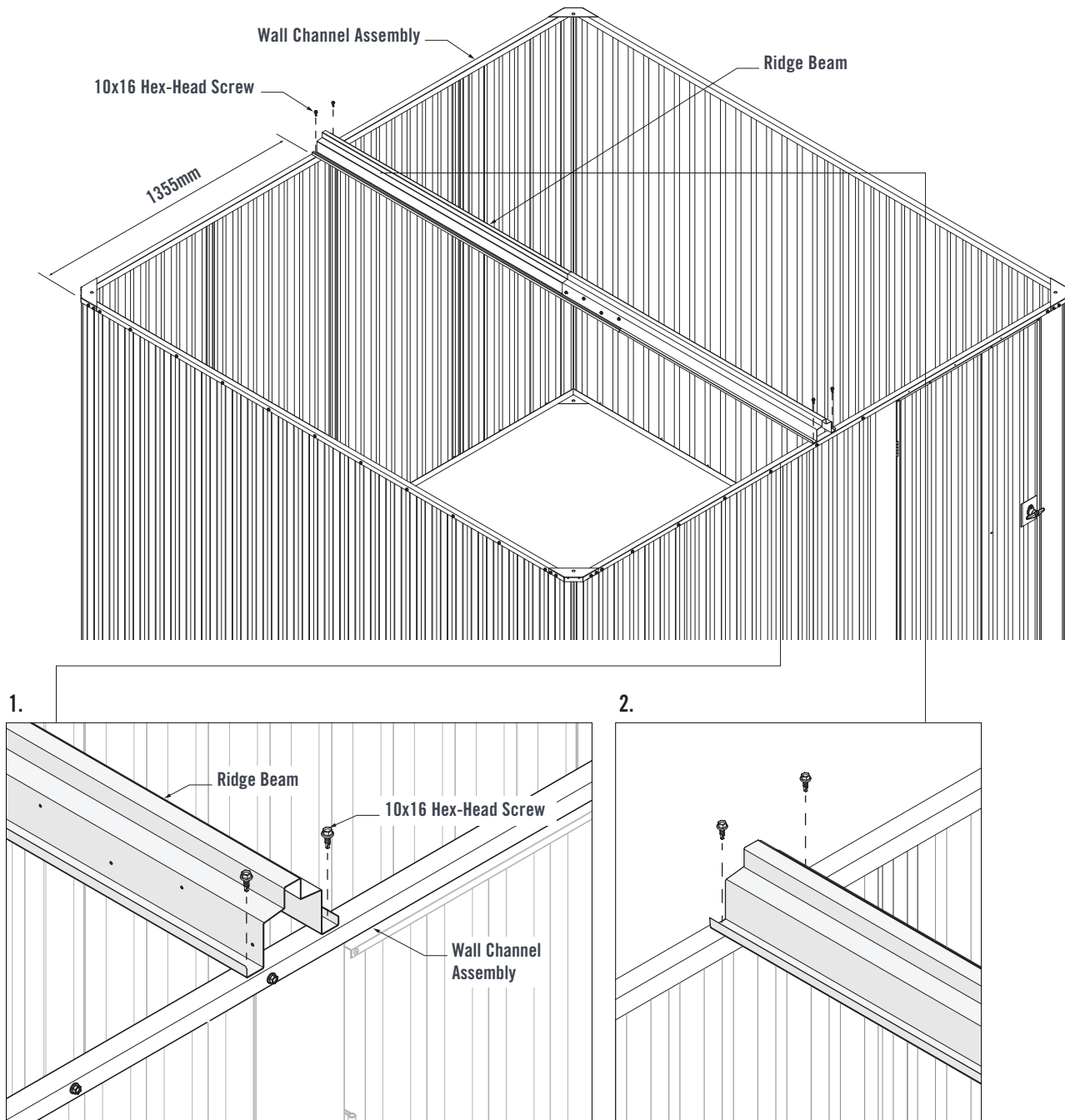

FIGURE 6.3

HANDI-MATE™ HM8 HINGED DOOR SHED INSTALLATION GUIDE

Refer to Sheet layout in Figure 6.2. Lay a Roof Sheet onto the Ridge Beam and Wall Channel Assembly, ensuring the overlap end of the Roof Sheet is facing the front of the shed (Figure 6.4).

1. Ensure the end of the Roof Sheet is in-line with the end of the Ridge Beam. Fasten five 10x16 Hex-Head Screws with Neo Washers through the pans of the Roof Sheet and into the Ridge Beam (Figure 6.4).

2. Fasten five 10x16 Hex-Head Screws with Neo Washers through the pans of the Roof Sheet and into the Wall Channel Assembly (Figure 6.4).

Install the opposing side Roof Sheet in the same manner.

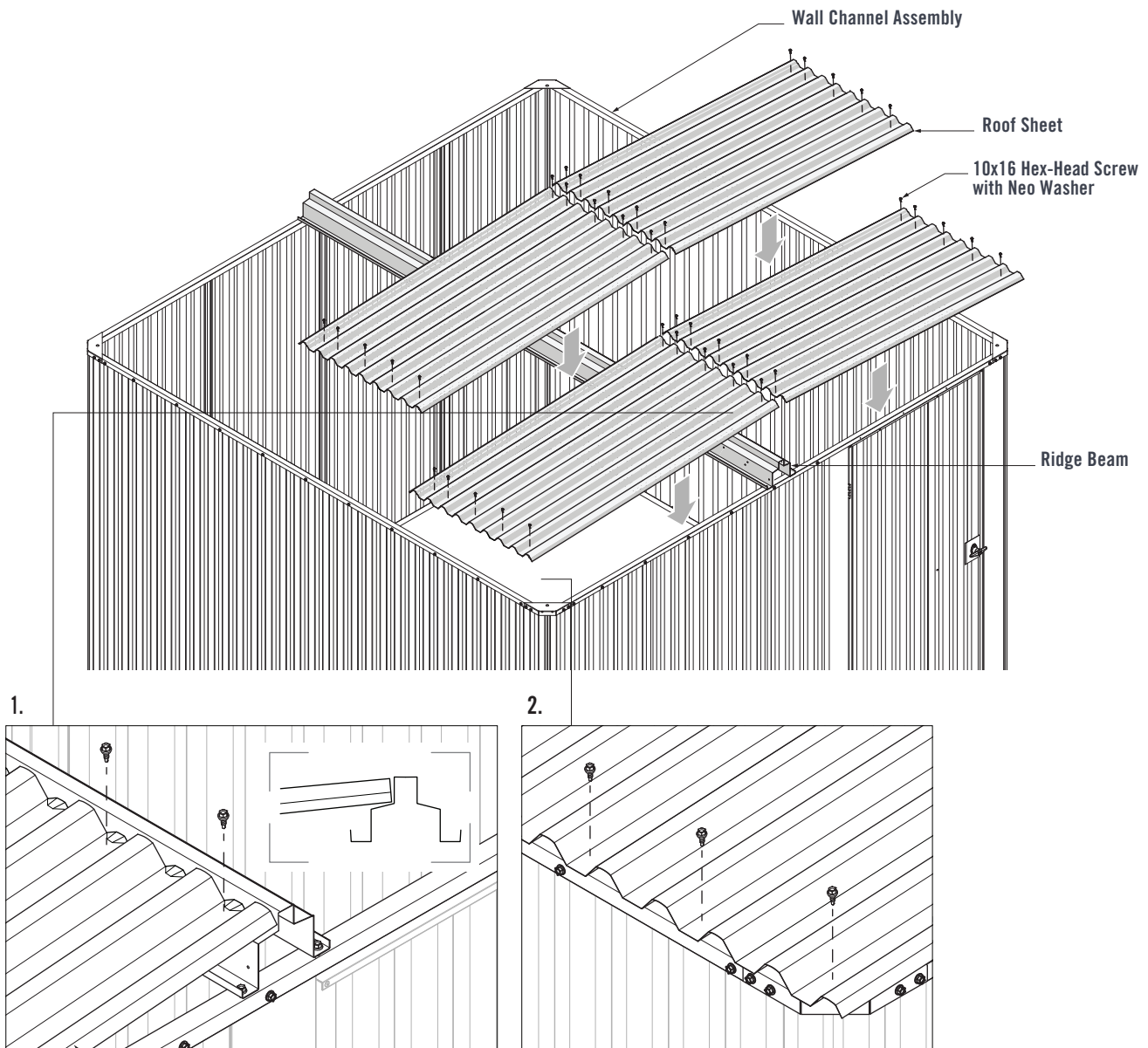

FIGURE 6.4

Position the Ridge Cap over the Ridge Beam. The end of the Ridge Cap should line up with the outer face of the Wall Channel (Figure 6.5).

Fasten the Ridge Cap to the Ridge Beam using three 10x16 Hex-Head Screws with Neo Washers (Figure 6.5).

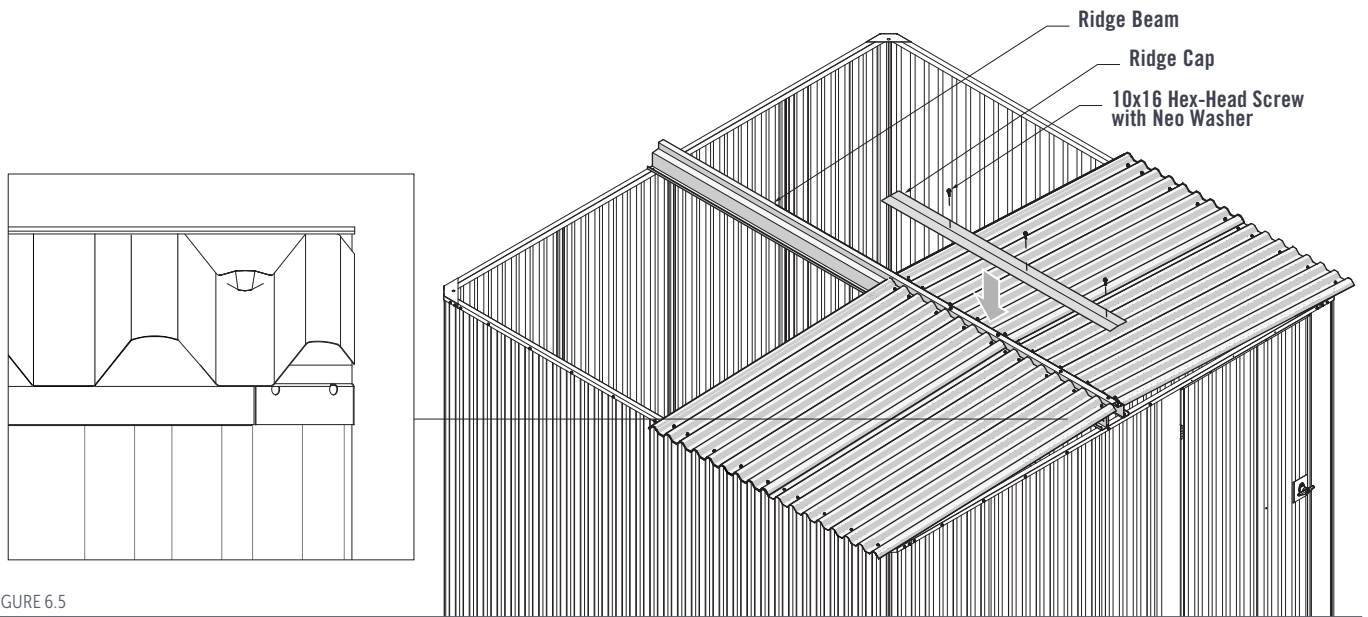

FIGURE 6.5

HANDI-MATE™ HM8 HINGED DOOR SHED INSTALLATION GUIDE

Refer to Sheet layout in Figure 6.2. Lay the next Roof Sheet onto the Ridge Beam and Wall Channel Assembly, ensuring the overlap end of the Roof Sheet is facing the front of the shed (Figure 6.6).

1. Ensure the Roof Sheet is hard against the step of the Ridge Beam. Fasten five 10x16 Hex-Head Screws with Neo Washers through the pans of the Roof Sheet and into the Ridge Beam (Figure 6.6).

2. Fasten five 10x16 Hex-Head Screws with Neo Washers through the pans of the Roof Sheet and into the Wall Channel Assembly (Figure 6.6).

Install the opposing side Roof Sheet in the same manner.

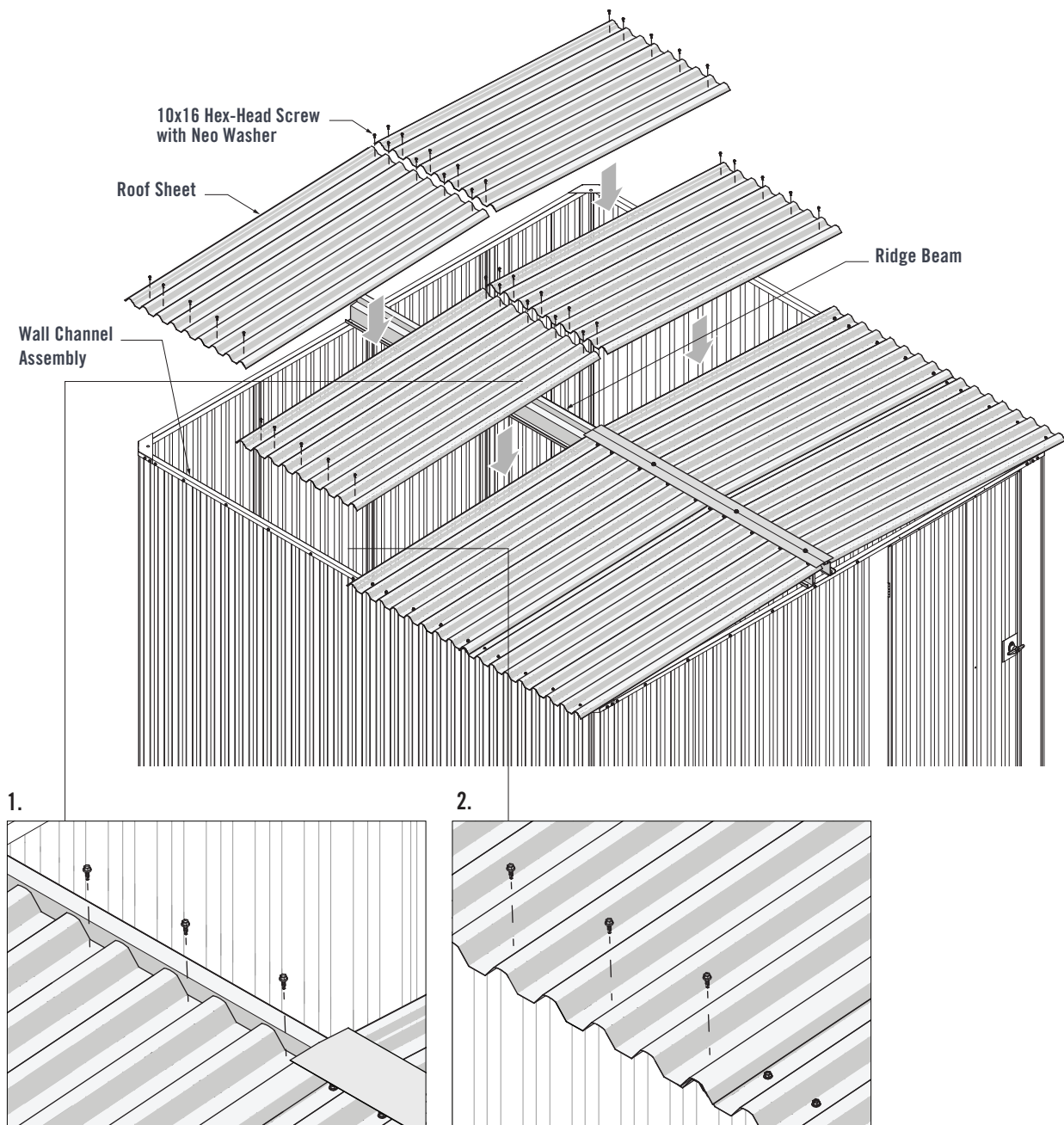

FIGURE 6.6

Position the Ridge Cap over the Ridge Beam. The end of the Ridge Cap should line up with the outer face of the Wall Channel (Figure 6.7).

Fasten the Ridge Cap to the Ridge Beam using four 10x16 Hex-Head Screws with Neo Washers (Figure 6.7).

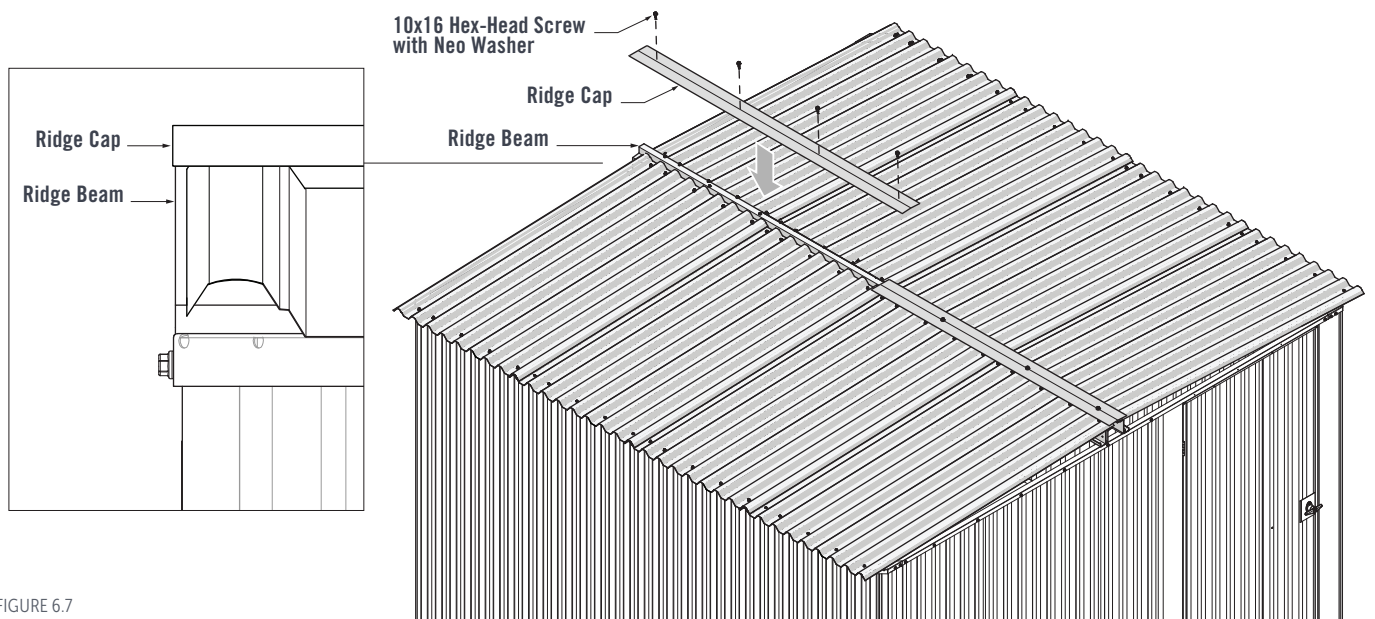

FIGURE 6.7

HANDI-MATE™ HM8 HINGED DOOR SHED INSTALLATION GUIDE

1. Place the L/H Barge Cap over the Roof Sheet at the front of the shed. The front face of the Barge Cap should fit up against the Roof Sheets (Figure 6.8).

2. The ends of the Barge Cap Should align with the end of the Roof Sheet. Fasten two coloured 10x25 Hex-Head Screws with Neo Washers through the front face of the Barge Cap and into the Wall Channel. Fasten two coloured 10x25 Hex-Head Screws with Neo Washers through the top of the Barge Cap and into the crests of the Roof Sheets (Figure 6.8).

Install the R/H Barge Cap in the same manner on the front right side of the shed. Install the remaining L/H and R/H Barge Caps to the rear of the shed in the same manner (Figure 6.8).

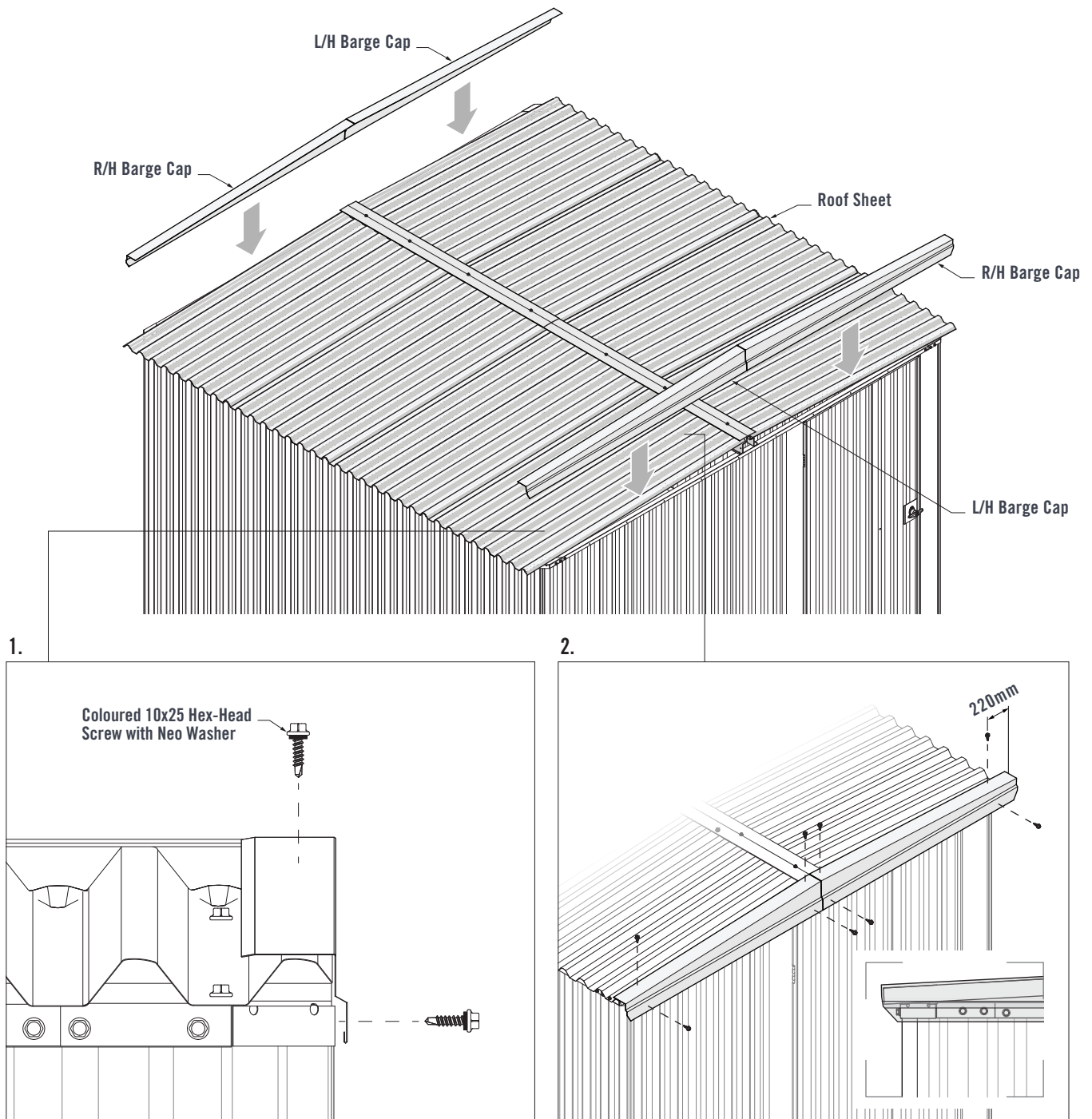

FIGURE 6.8

A coloured Rivet should be installed at sheet laps in the Roof Sheets, Rear Wall, Wall Corners and Door Jambs. Drill a 3.5mm hole through the centre of each sheet lap and install a coloured Rivet (Figure 6.9).

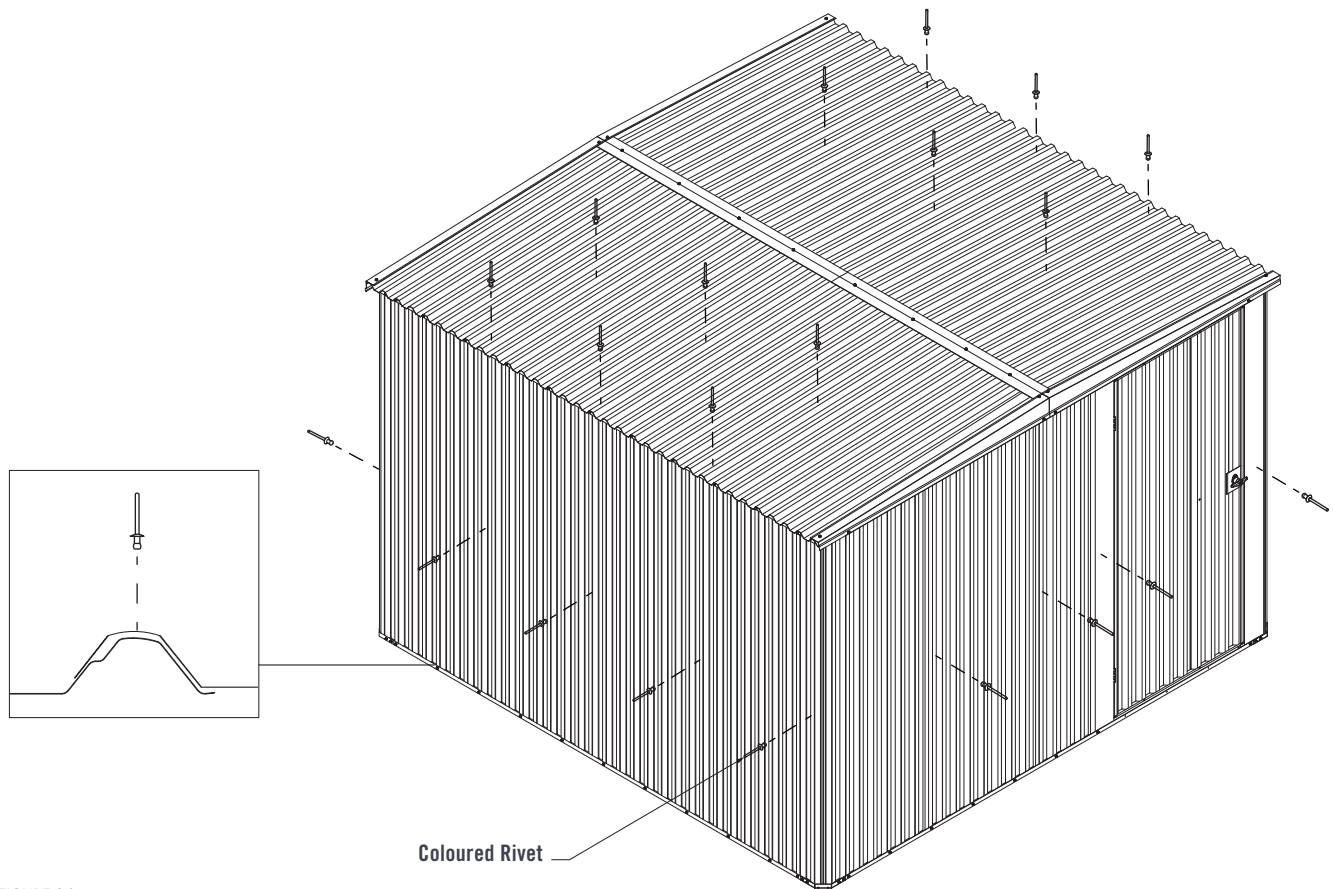

FIGURE 6.9

Water-Proofing the Floor (Optional)

Water may enter the Shed between the bottom Wall Channels and Floor. Water ingress can be mitigated by applying silicone to the gaps along the Floor. From the inside of the Shed, apply a bead of silicone along the entire perimeter of the Shed, including along the Corner Brackets and Wall Channel ends. Do not apply silicone to the outside of the Shed as this will not allow water to flow out and away from the Shed (Figure 6.10).

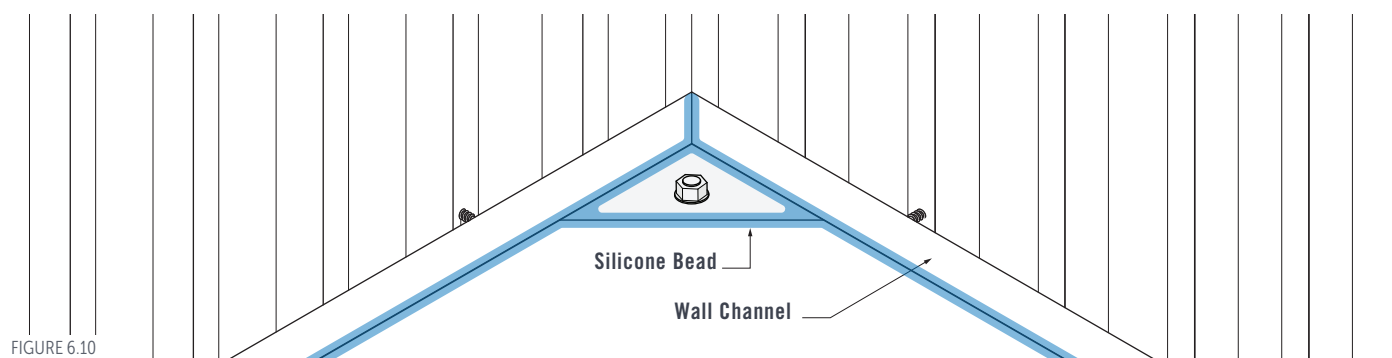

FIGURE 6.10

SHED MAINTENANCE

It is vital that all metal swarf and filings are removed from the shed as to prevent rust spots from forming. Your Stratco Handi-Mate™ Shed will maintain its good looks for even longer with a simple wash and wipe down. Cleaning should be performed as often as is required to remove any dirt, salt and pollutants.

Stratco Handi-Mate™ Sheds are produced from the highest quality materials and will provide many years of service. Refer to the 'Selection Use and Maintenance' brochure for more information on how to get the best out of your product.

WINDOW INSTALLATION

Stratco Shed Windows are an optional add-on, available in both Louvre and Sliding variations. Installation methods are identical for each window type. Windows can be installed to the front, rear or side walls of the shed.

The Window must be installed during the assembly of the Wall.

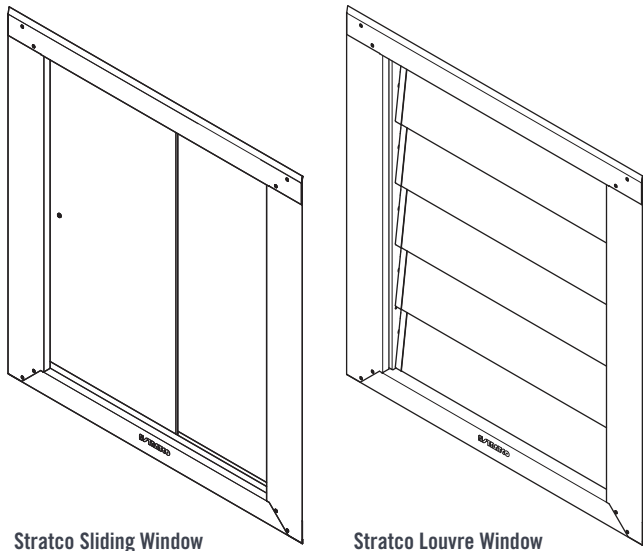

FIGURE 7.0

Lay a Wall Sheet on trestles or blocks. Mark and cut 750mm from the end of the Wall Sheet (Figure 7.1).

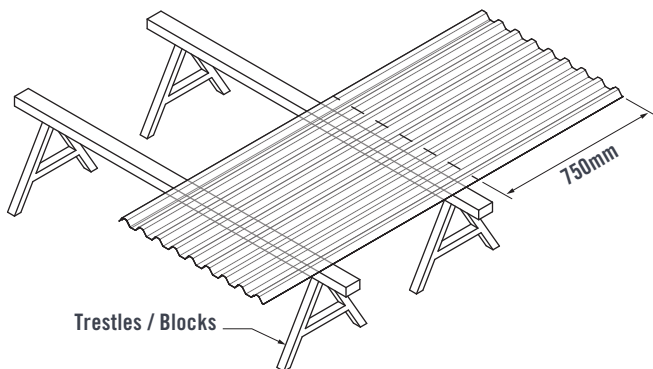

FIGURE 7.1

Assemble the Wall Assembly as per the "Wall Assembly" section of the install guide using below sheet layout (Figure 7.2).

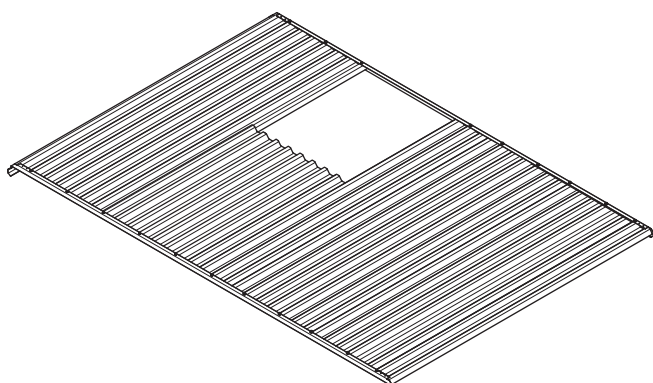

FIGURE 7.2

Fit the window within the opening. Ensure the top lip of the window is fitted between the Wall Channel and Wall Sheets. A minimum of four evenly spaced rivets must be used along each side of the window frame. All fasteners must be fixed through the crests of the Wall Sheets (Figure 7.3).

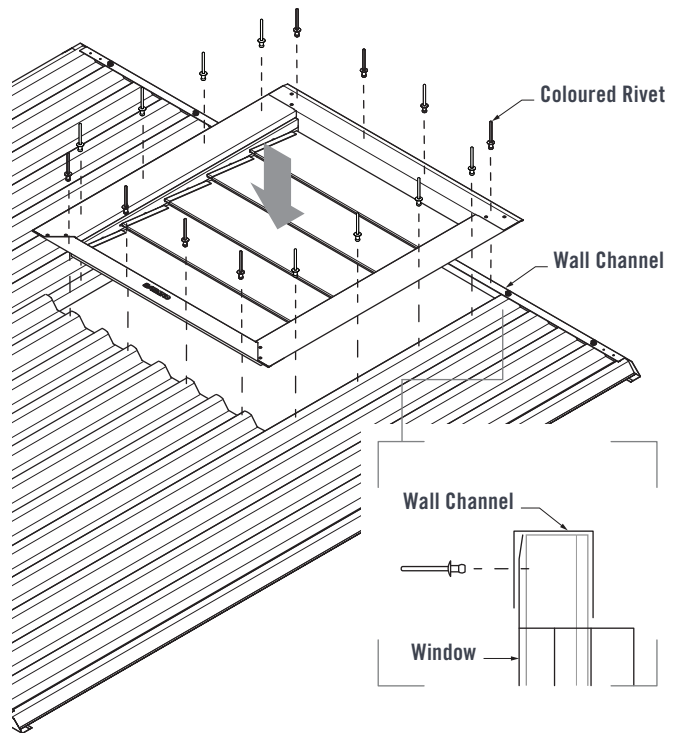

FIGURE 7.3

The Window Flashing must be fitted from the inside of the shed. Fit the short face of the Flashing between the window and the cut edge of the Wall Sheet. Secure the flashing to the Wall Sheet with four evenly spaced Rivets. Ensure all rivets are crest-fixed through to the sheets (Figure 7.4).

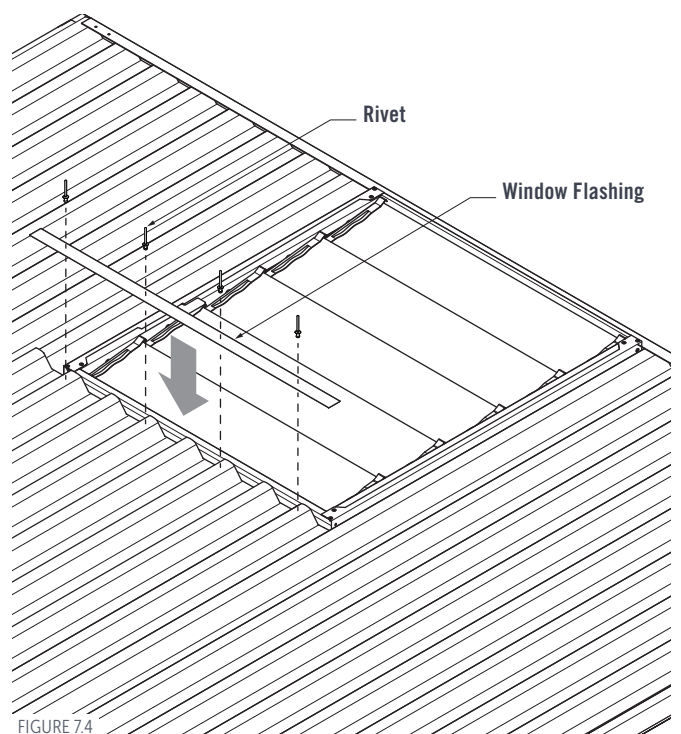









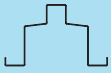
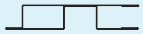

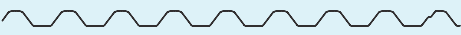

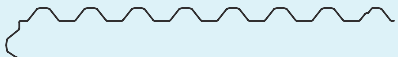







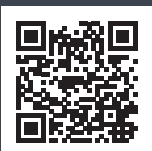

FIGURE 7.4

**COMPONENT INDEX**

PROFILE	DESCRIPTION	PRODUCT CODE
	Door Handle	HMTH
	Door Handle Tongue	HMDTHDR
	Corner Bracket	HMCB
	Door Shroud	HMDSHDRBO
	Wall Channel - 1400mm	HMWC1400
	Wall Channel Joiner	HMWCJ
	Barge Cap - Left Hand Side	HMBCHDRL
	Barge Cap - Right Hand Side	HMBCHDRR
	Ridge Cap	HMRC
	Ridge Beam, Ridge Beam Joiner	HMRB, HMRBJ
	Door Jamb	HMDJHDC
	Complete Door & Jamb Assembly	HDJAHDC
	Roof Sheet	SSPHMRS
	Split Wall Sheet	SSPHMSW
	Corner Wall Sheet	SSPHMWSCNR
	Wall Sheet	SSPHMWS
	Hold Down Lug	HMHL
	Masonry Anchor	MAA847
	Rivet	RIV4-3
	22mm Wafer Head Screw	WTK1022
	16mm Self-Drilling Screw	TEKNNW1016
	16mm Self-Drilling Screw Neo Washer	TEK1016
	25mm Self-Drilling Screw Neo Washer	TEK1025



« SCAN THIS QR CODE TO FIND A STRATCO NEAR YOU

1300 155 155
stratco.com.au

All brands and logos/images accompanied by ® or ™ are trade marks of Stratco (Australia) Pty Limited. © Copyright July 2023

How To.